

g·tec

discover the colors of science.



ADVANCED BIOSIGNAL
ACQUISITION, PROCESSING
AND ANALYSIS

PRODUCTS 2011/12

g.tec medical engineering GmbH

Sierningstrasse 14
4521 Schiedlberg
Austria

phone +43 7251 22240-0
fax +43 7251 22240-39
email office@gtec.at

GUGER TECHNOLOGIES OG

Herbersteinstrasse 60
8020 Graz
Austria

phone +43 316 675106
fax +43 316 675106-39
email office@gtec.at

g.tec medical engineering Spain

Calle Pallars 74-76, 3-1
08018 Barcelona
Spain

phone +34 933 0910 77
email delavega@gtec.at

www.gtec.at







Copyright © 2011 g.tec medical engineering GmbH, Austria.

Layout: Grafik Krausz, www.grafikrausz.at
Photography: g.tec, F. Feinkorn www.feinkorn.at
Printed in EU.

Subject to technical modifications.

Note: Some of the product names, patents, and registered designs referred to in this booklet are in fact registered trademarks or proprietary names even though specific reference to this fact is not always made in the text. Therefore, the appearance of a name without designation as proprietary is not to be construed as a representation by the publisher that it is in the public domain. All rights reserved. No part of this publication may be translated, reprinted or reproduced, transmitted in any form or by any means, electronic or mechanical, now known or hereafter invented, including photocopying and recording, or utilized in any information storage or retrieval system without the prior written permission of the copyright holder.

INDEX

 Welcome	
Awards	02
Projects and Acknowledgements	04
History and Company Profile	05
 Hardware and Accessories	
g.HIamp : multi-channel biosignal data acquisition and processing system	08
g.USBamp : high accuracy biosignal data acquisition and processing system	12
g.BSamp : stand-alone analog biosignal amplifier	18
g.MOBIIab⁺ : wireless biosignal acquisition system in your pocket	20
g.TRIGbox : multimodal trigger system	24
Electrical current stimulator and timing unit	25
g.STIMbox : stimulator digital I/O box	26
g.PAH : programmable attenuator headphone buffer for experimental audiology	27
g.EYEtracker : real-time eyetracking system	28
g.HEADstage : miniaturized headstage amplifier system for single neuron spike recording	29
g.VRsys : virtual reality research system	30
Accessories for your lab	32
 Software	
Overview	34
g.Recorder : biosignal recording software and g.FEATUREmonitor	35
g.HIsys : high-speed online processing for LabVIEW	37
g.HIsys : high-speed online processing for SIMULINK	39
g.RTanalyze : online and real-time biosignal processing library for use with SIMULINK	41
g.BSanalyze : offline biosignal analysis under MATLAB or stand alone with powerful toolboxes	42
MATLAB API : device driver for the MATLAB data acquisition toolbox	52
C API : application programming interface for Windows and Linux	53
g.UDPinterface : exchange data over networks	54
 Complete Systems	
g.BCIsys : complete BCI research systems	56
g.BCI2000sys : complete BCI research systems based on BCI2000 open source platform	60
g.EEGsys : complete EEG research systems	61
intendiX : personal EEG-based spelling system	62
 Electrodes and Electrode Systems	
g.EEGcap : EEG cap and electrode system	64
g.GAMMAcap² for active/passive/dry electrodes	66
g.GAMMAsys : active electrode system	67
g.SAHARAsys : dry active electrode system	69
Electrodes and Consumables : misc cables, electrodes and consumables	71
 Sensors	
Continuous non-invasive blood pressure monitoring sensor	74
Snoring sensor	74
Temperature sensor	74
Respiration airflow sensor	75
Respiration effort sensor	75
Oxygen saturation sensor	75
Pulse sensor	76
Galvanic Skin Response (GSR)	76
Acceleration sensor	76
Limb movement sensor	76
 Lectures and Books	
Lectures	78
Books	80

The Annual BCI Research Award



“We have a vital interest in promoting excellence in the field of BCI. Achieving our goal to make BCIs more powerful, more intelligent and more applicable for patients’ and caregivers’ everyday life strongly relies on a creative research community worldwide.”

The prize, endowed with 3,000 USD and donated by g.tec, is an accolade to recognize outstanding and innovative research done in the field of Brain-Computer Interfaces. Each year, a renowned research laboratory is asked to judge the submitted projects and to award the prize. The jury consists of world-leading BCI experts recruited by the awarding laboratory.

For more information see www.bci-award.com

g.tec has been awarded with the following prizes

Forward Award 2000 / GEWINN Award for Innovation 2001 / Austrian Prize of Innovation 2001
CinC challenge 2006 for the g.BSanalyze ECG toolbox / GEWINN-Jungunternehmerpreis 2006 / Personal prize of ÖGAHM 2007
European ICT Prize 2007 / Well-Tech Award 2007 / Fast Forward Award 2008 / Econovius 2008 / science2business Award 2010
Microsoft Innovation Award 2010 / Pegasus Award 2011

Master Student Awards: GIT-Prize 2008 / Innovation & Economy Division Health 2010 / Project Award 2009 / jugend innovativ 2009
Constantinus Award 2010 / Prix ARS Electronica 2010 acknowledgement / Innovation & Economy Division Health 2011

g.tec Welcome



g.tec is powered by

- ◆ SFG – Steirische Wirtschaftsförderung
- ◆ FFG – Forschungsförderungsfonds der gewerblichen Wirtschaft
- ◆ FET – Future and Emerging Technologies
- ◆ IST – Information Society Technologies
- ◆ ICT – Information and Communication Technologies

g.tec is actively involved in research and scientific publications
and is an active member, advisor or partner of the following research projects



www.aal-alias.eu



www.argealpinmed.at



www.iai.csic.es/better



www.brainable.org



www.eniac-csi.org/CSI



www.decoder-project.eu



<http://future-bncl.org>



www.presencia.org



www.renachip.org



www.iaa.upf.edu/rgs



<http://specs.upf.edu/sf>



www.sm4all-project.eu



www.tobi-project.org



www.vereproject.eu

Welcome to the biomedical engineering world of g.tec!

g.tec was founded in 1999 and consists now of two divisions:

- ◆ GUGER TECHNOLOGIES OG (development, research and production)
- ◆ g.tec medical engineering GmbH (sales, marketing/PR and research)

g.tec is a growing enterprise with two branches in Austria (Graz and Schiedlberg) and Spain (Barcelona) and distribution partners all over the world. All hardware and software development is done in-house by our team of researchers, engineers and developers. g.tec is also an active member in a number of national and international research projects and is active in scientific publishing.

g.tec developed the first commercially available BCI system in 1999 and now sells this system in more than 60 countries worldwide. Our products work with all major BCI approaches (motor imagery, P300, SSVEP and slow cortical potentials), so you can start BCI research within a few hours. The g.tec team tests different BCI technologies on more than 500 subjects internationally to guarantee a perfect working system.

Our team is prepared to find the better solution for your needs.

Take advantage of our experience!



Dr. Guenter Edlinger (CEO)



Dr. Christoph Guger (CEO)



Ing. Mag. Gunther Krausz
Head of Research & Development, Marketing



DI Franz Laundl
Head of Development



DI Ingo Niedermeyer
Head of Production



Hardware and Accessories

Pathbreaking technology for brain mapping



High demands lead to high level solutions and pathbreaking technology. g.HIamp is a 256 channel biosignal amplifier for invasive and non-invasive measurements of brain functions that is CE approved. The amplifier has 256 ADC converters with 24 Bit inside for perfect signal resolution and has a wide input sensitivity to be able to measure EEG, ECoG, ECG, EMG, EOG without any saturation. Additionally external sensors can be connected. All channels are DC coupled. Internally signal processing is performed with the fastest floating point DSP and a sophisticated Linux Kernel. The amplifier performs a very high oversampling to reduce the noise as much as possible by averaging samples.

256 channels can be analyzed in real-time with the g.tec Highspeed Processing for SIMULINK toolbox. This leads to faster and more accurate control of brain-computer interface systems done with Common Spatial Patterns (CSP).

g.HIamp is powered by a medical mains power supply or by a battery pack and the system is connected to the computer via USB. The system is equipped with 16 digital trigger channels and a HOLD input for artifact suppression (e.g. during electrical or magnetical stimulation).

g.HIamp provides 80, 144 or 256 channels per unit. 80 and 144 channel systems can also be upgraded later on. Each block of 64 channels is connected via a multi-pole medical safety connector to the electrode interface box.

A big advantage is that g.HIamp can be used with passive or active electrodes. The difference is just the electrode connector box (headbox). For ECoG grids and strips special interface connectors are available.

PRODUCT HIGHLIGHTS

- ◆ 256 channels perfectly synchronized with 24 Bit
- ◆ supports active and passive EEG electrodes and ECoG grids
- ◆ CE certified medical product
- ◆ fully integrated into g.tec software for real-time analysis
- ◆ integrated impedance measurement for active and passive electrodes



Input Channel Properties

g.Hlomp uses wide-range DC-coupled amplifier technology in combination with 24-bit sampling. The result is an input voltage of +/- 250 mV with a resolution of <60nV! This means that every electrophysiological signal can be recorded directly without additional hardware. Neither high electrode offset voltage nor big artifacts resulting from electrical or magnetic stimulation will saturate the amplifier inputs. This feature is important for various artifact treatment and correction algorithms. The use of digital filters avoids hardware related variations between channels.

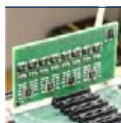

Accuracy and data quality

The amplifier is driving each ADC with 614,4 kHz which is much higher than the required sampling frequency. Then internally the floating point DSP performs the oversampling and averages samples to increase the signal-to-noise ratio. If the amplifier works e.g. with 256 Hz then 2400 samples are averaged and this suppresses the noise by a factor of 49. In addition the floating point DSP performs also the real-time bandpass filtering and NOTCH filtering of the data. Several hundred different bandpass filters are predefined. Also bipolar derivations can be calculated by the DSP to work with a very high CMRR. The amplifier uses 256 ADC for the 256 channels and therefore all signals are sampled exactly at the same time point to avoid any time delay between channels. This is especially important for brain mapping procedures.



Add more channels

g.Hlomp can be ordered with 64+16, 128+16 or 256 channels initially. The 64+16 channel version comes with one 64 and one 16 channel connector box. The 128+16 version comes with two 64 channel and one 16 channel connector box and the 256 channel version comes with four 64 channel boxes. Later on if more channels are required the amplifier can be upgraded by inserting more amplifier channels. This allows to start with a cheaper setup.



Skin-electrode impedance

g.Hlomp uses a new principle for impedance measurement. This allows the amplifier to determine the skin-electrode impedance for passive and also for active electrodes connected to the amplifier. It works also for gel or dry electrodes provided by g.tec. The internal impedance testing unit measures the impedance of the individual electrodes and the results are displayed in the software. Bad electrodes can be identified easily and skin treatment and gel application can be performed during the impedance testing.



Software options

g.tec's philosophy is to provide a broad spectrum of software solutions for different groups of users (e.g. for engineers, researchers & scientists, physiologists, and medical staff, but also for software developers & programmers). From comfortable Windows-based recording software to MATLAB/Simulink based tools and device drivers and APIs you will find the appropriate tools for your application. Please see the list of related products/software below for more details. g.Hlomp is also supported and integrated into the main core of BCI2000.



Important information

As with all g.tec biosignal amplifiers, we give a full 5-years warranty on g.Hlomp. g.Hlomp is a safe certified medical device for research in humans, even for invasive recordings such as electrocorticography (ECoG). It must not be used for patient monitoring or determination of brain death. Medical diagnosis and decisions about treatment of diseases must not be based (solely) on results obtained with this device.

TECHNICAL DETAILS AND SPECIFICATIONS

Sensitivity	<60nV (LSB), +/-250mV	Input impedance	>100 MOhm
Amplifier type	real DC coupled	Input connectors	standard safety connectors for passive electrodes, 2-pin connectors for active electrodes
256 x ADC	24 Bit (38.4 kHz internal sampling per channel)	Weight	1,875 g
DAC	calibration signal	Size	197 (L) x 197 (W) x 90 (H) mm
Input channels	256 mono-polar / 128 bi-polar (per device, software selectable)		
CE certified medical device		Standards	EN60601-1, EN60601-1-2, EN60601-2-25, EN60601-2-26, EN60601-2-40, MDD 93/42/EEC, EN60601-1-4, EN ISO 14971, ANSI/AAMI SW68:2001
Applied part	CF		
Safety class	II		

CONNECT ACTIVE/PASSIVE ELECTRODES

A brilliant feature of the g.Hlomp is that the main amplifier unit can be used with different electrode connector boxes. Therefore the main amplifier unit is only purchased once and can be used for many different applications:

 <p>g.HEADbox - passive 7006</p> <p>passive electrode connector box - comes with 64 channels and is connected to one of the 4 groups of g.Hlomp. It can be used with standard 1.5 mm safety connectors which are standard for EEG and ECoG electrodes.</p>	 <p>g.HEADbox - active 7005</p> <p>active electrode connector box - comes with 64 channels and is connected to one of the 4 groups of g.Hlomp. It has 2-pin connectors to support all g.tec active electrodes such as g.LADYbird or g.BUTTERFLY.</p>	 <p>g.HEADbox16 - passive 7007</p> <p>passive electrode connector box with 16 channels - comes with 16 channels and is connected to one of the 4 groups of g.Hlomp. This connector box is useful to have additional inputs for external sensors.</p>
---	---	---

HARDWARE

Product no.	Product name	Description
7001	g.Hlamp 80	multi-modal biosignal amplifier (silver) with USB interface; 64+16 channels; bi-, unipolar recordings; can be upgraded to a 144 or 256 channel system; 16 digital trigger inputs to synchronize with external events; integrated electrode impedance check; integrated calibration unit; CE-certified medical device EN 60601-1 (IEC 60601-1); device driver for Microsoft Windows 7 32/64 bit; internal sampling frequency 38.4 kHz per channel; highest signal-to-noise ratio; multi-pole medical connectors, classification of device: safety class II, type of applied part CF, conformity class IIa; g.Hlamp water-proof heavy duty case (7051); including g.Hlamp USB cable (7282); standard color: silver, different colors on request (SN: HA-XXXX.XX.XX)
7002	g.Hlamp 144	multi-modal biosignal amplifier (silver) with USB interface; 128+16 channels; bi-, unipolar recordings; can be upgraded to a 256 channel system; 16 digital trigger inputs to synchronize with external events; integrated electrode impedance check; integrated calibration unit; CE-certified medical device EN 60601-1 (IEC 60601-1); device driver for Microsoft Windows 7 32/64 bit; internal sampling frequency 38.4 kHz per channel; highest signal-to-noise ratio; multi-pole medical connectors, classification of device: safety class II, type of applied part CF, conformity class IIa; g.Hlamp water-proof heavy duty case (7051); including g.Hlamp USB cable (7282); standard color: silver, different colors on request (SN: HA-XXXX.XX.XX)
7003	g.Hlamp 256	multi-modal biosignal amplifier (silver) with USB interface; 256 channels; bi-, unipolar recordings; 16 digital trigger inputs to synchronize with external events; integrated electrode impedance check; integrated calibration unit; CE-certified medical device EN 60601-1 (IEC 60601-1); device driver for Microsoft Windows 7 32/64 bit; internal sampling frequency 38.4 kHz per channel; highest signal-to-noise ratio; multi-pole medical connectors, classification of device: safety class II, type of applied part CF, conformity class IIa; g.Hlamp water-proof heavy duty case (7051); including g.Hlamp USB cable (7282); standard color: silver, different colors on request (SN: HA-XXXX.XX.XX)
7004	g.Power – g.Hlamp	medical mains power supply for g.Hlamp; 110/230 V; 50/60 Hz power line; single 5 V supply
7005	g.HEADbox - active	electrode interface box for 64 active channels, for usage with g.Hlamp; works with g.tec 2 pin safety connector active electrodes; g.INTERfaceHEADbox2Hlamp (7008); g.HEADboxPOWER (7009)
7006	g.HEADbox - passive	electrode interface box for 64 passive channels, for usage with g.Hlamp; works with 1,5 mm medical safety connector passive electrodes; g.INTERfaceHEADbox2Hlamp (7008);
7007	g.HEADbox16 - passive	electrode interface box for 16 passive channels, for usage with g.Hlamp; works with 1,5 mm medical safety connector electrodes
7008	g.INTERfaceHEADbox2Hlamp	interface cable g.HEADbox to g.Hlamp with mult pole connector
7009	g.HEADboxPOWER	power supply cable for g.HEADbox
7225	g.Hlamp cable for short-cut function (SC)	3m cable with 3pin screw terminal
7282	g.Hlamp USB cable	connection of g.Hlamp to USB-port of PC/notebook
7277	adapter cable for trigger cable	DSUB25 female to 8xBNC (including 8xBNC to CINCH adapter)
7276	trigger cable for g.Hlamp	for 8 digital lines to DIG IN 1 or 8 digital lines to DIG IN2 g.Hlamp HA-xxxx.xxx to D_Sub 25 male (parallel port), 3m
3012	medical isolation transformer	600 VA, EN/IEC 60601-1, 6 outputs
7051	g.Hlamp water-proof heavy duty case	100 % water-proof heavy duty case for g.Hlamp equipment
10040	Medical device inspection	recurring medical device inspection (EN 62353: 2008) for g.Hlamp, g.USBamp or g.BSamp
0223	shortcut jumper cable	shortcut cable for 2 channels; medical safety connector; can be daisy chained



SOFTWARE

Product no.	Product name	Description
0167d	g.Recorder for g.HIamp	fully GUI-based (graphical user interface); comfortable biosignal visualization and storage; full control of the amplifier and header; real-time compressed spectral array; heart-rate, heart-rate variability; webcam; single place licence; prerequisite OS English Win 32/64
0132	g.FEATUREmonitor	multi-channel and multi-modal (cerebral function) biosignal parameter observation software; prerequisite: g.Recorder (0167) ; single place licence
0260d	g.HIamp SIMULINK HIGH-SPEED ONLINE Processing	SIMULINK driver and blockset modules; highly optimized hardware-interrupt controlled device driver; allowing data processing with the maximum system speed; supports real-time processing of the biosignal data; calibration block; impedance measurement block; signal analysis blocks; single place licence; prerequisite MATLAB R2011a for OS English Win 32/64 (Windows 7), SIMULINK and Signal Processing Blockset
0291	g.EYEtracking Interface for SIMULINK	read eyetracking information into Simulink; single place licence; prerequisite MATLAB R2011a for OS English Win 32 (Windows 7), SIMULINK
0139d	g.HIamp P300 model	8-channel P300 based speller; prerequisite: SIMULINK HIGH-SPEED ONLINE Processing (0260d)
0140d	g.HIamp Ping Pong model	2 subject and 4-channel motor imagery based game; prerequisite: SIMULINK HIGH-SPEED ONLINE Processing (0260d)
0141d	g.HIamp SSVEP BCI model	8 channel SSVEP based control; prerequisite SIMULINK HIGH-SPEED ONLINE Processing for g.HIamp, g.RTanalyze
1303d	SSVEP model and Hardware for g.USBamp	bundle for SSVEP based robot control; consists of g.HIamp SSVEP BCI model, g.SSVEPbox for stimulation, g.STIMbox to run g.SSVEPbox and small robot with bluetooth interface; prerequisite SIMULINK HIGH SPEED ONLINE processing for g.HIamp, g.BSanalyze Base, EEG & Classify Toolboxes, g.RTanalyze; (0141d, 1300, 1302, 1501)
0142b	g.HIamp common spatial patterns	Simulink model to calculate CSPs of 27 electrodes, tutorial; prerequisite: SIMULINK HIGH-SPEED ONLINE Processing (0260d)
0111	g.RTanalyze	real-time EEG, ECG, respiration, galvanic skin response and biosignal processing blockset under SIMULINK; real-time algorithms; single place license; prerequisite MATLAB R2011a for OS English Win 32/64 (Windows 7), SIMULINK
7263	g.HIamp C API	application programming interface (API) for user specific application (eg. developed in C/C++); single place licence; prerequisite OS English Win 32/64 (Windows 7)
7263a	g.HIamp C API + BCI2000	application programming interface (API) for user specific application (eg. developed in C/C++); BCI2000 driver, BCI2000 software package; single place license; prerequisite OS English Win 32/64 (Windows 7)
0264	g.UDPinterface	data exchange with network connection between Simulink/MATLAB on different PCs (eg. BCI, VR, XVR, ...); single place licence; prerequisite MATLAB R2011a for OS English Win 32/64 (Windows 7), SIMULINK

University/education prices available

COMPLETE SOLUTIONS

Product no.	Product name	Description
8000	g.HIamp 80 package BASE, PC included	base system for EEG recordings; consisting of: g.HIamp 64+16 (biosignal amplifier, CE-certified, with power supply); g.HEADbox-passive (electrode interface box, passive for 64 channels); g.HEADbox16 (electrode interface box, passive for 16 channels); trigger cable for g.HIamp; g.Recorder; fully equipped business PC (with software ready-to-go installation); bundle offer (7001, 7004, 7006, 7007, 7276, 0167d, 3001a)
8001	g.HIamp 144 package BASE, PC included	base system for EEG recordings; consisting of: g.HIamp 128+16 (biosignal amplifier, CE-certified, with power supply); g.HEADbox-passive (electrode interface box, passive for 64 channels); g.HEADbox16 (electrode interface box, passive for 16 channels); trigger cable for g.HIamp; g.Recorder; fully equipped business PC (with software ready-to-go installation); bundle offer (7002, 7004, 7006, 7007, 7276, 0167d, 3001a)
8002	g.HIamp 256 package BASE, PC included	base system for biosignal recordings; consisting of: g.HIamp 256 (biosignal amplifier, CE-certified, with power supply); g.HEADbox-passive (electrode interface box, passive for 64 channels); g.HEADbox16 (electrode interface box, passive for 16 channels); trigger cable for g.HIamp; g.Recorder; fully equipped business PC (with software ready-to-go installation); bundle offer (7003, 7004, 7006, 7007, 7276, 0167d, 3001a)
8003	g.HIamp 80 package ACTIVE	active electrode upgrade for g.HIamp 80 package BASE consisting of: g.HEADbox-active (electrode interface box, active for 64 channels); g.GAMMAcap2SET; g.GAMMAcap2BELT; 70 g.LADYbird electrodes; g.LADYbirdGND; g.GAMMAearclipAg/AgCl; bundle offer (7005, 1027, 1028, 70x1033, 1034, 1039)
8004	g.HIamp 144 package ACTIVE	active electrode upgrade for g.HIamp 144 package BASE consisting of: 2 g.HEADbox-active (electrode interface box, active for 64 channels); g.GAMMAcap2SET; g.GAMMAcap2BELT; 130 g.LADYbird electrodes; g.LADYbirdGND; g.GAMMAearclipAg/AgCl; bundle offer (2x7005, 1027, 1028, 130x1033, 1034, 1039)
8006	g.HIamp package BCI	upgrade for BCI research consisting of: g.HIamp SIMULINK HIGH-SPEED ONLINE Processing Software (drivers and blocksets for SIMULINK); g.HIamp P300 model; g.HIamp Ping Pong model; g.HIamp SSVEP model; g.HIamp common spatial patterns; g.RTanalyze (real-time software for biosignal parameter extraction); g.BSanalyze (Base version + EEG toolbox + Classify toolbox for offline data processing, analysis and classification); bundle offer (0260d, 0139d, 0140d, 0141d, 0142b, 0111, 0101, 0102, 0105)
8007	g.HIamp 80 CARDIObundle, PC included	system for ECG and blood pressure recordings; consisting of: g.HIamp 64+16 (biosignal amplifier, CE-certified, with power supply); g.HEADbox-active (electrode interface box, active for 64 channels); g.HEADbox16 (electrode interface box, passive for 16 channels); g.CNAPsensor (non invasive continuous blood pressure measurement); g.GAMMAclip, g.GAMMAclipGND, g.GAMMAclipREF; disposable Ag/AgCl electrodes; g.HIamp SIMULINK HIGH SPEED ONLINE PROCESSING (drivers and blocksets for SIMULINK); g.BSanalyze Base version, ECG I & II Toolboxes; fully equipped business PC (with software ready-to-go installation); bundle offer (7001, 7005, 7007, 2044a, 12x1024, 2x1025, 2x1047, 10x1032, 0260d, 0101, 0104a, 0104b, 3001a)

University/education prices available



g.USBamp 3.0
USB BIOSIGNAL AMPLIFIER

g.tec's highest accuracy biosignal data acquisition and processing system

g.USBamp is a high-performance and high-accuracy biosignal amplifier and acquisition/processing system. It allows investigation of brain-, heart- and muscle-activity, eye movements, respiration, galvanic skin response and many other physiological and physical parameters. Due to its technical specifications and various software options, this instrument became a standard for many different fields of research, including neuropsychology, life science, medical research and biofeedback/neurofeedback/BCI research.

g.USBamp is USB 2.0 enabled and comes with 16 simultaneously sampled biosignal channels with 24 bits. A total of 4 independent grounds guarantee no interference between the recorded signals.

Build a multi-channel system with more than 16 channels using multiple g.USBamp devices. A synchronization cable guarantees that all devices are sampling with exactly the same frequency.

The amplifier has an input range of ± 250 mV, which allows recording of DC signals without saturation.

Digital inputs and outputs allow the recording of trigger channels together with the biosignal channels to easily pass analysis results to the outside world.

A short-cut input allows connecting the amplifier inputs quickly to ground potential to protect the amplifier against overflows, which may occur in operating rooms with gamma knives or other environments.

PRODUCT HIGHLIGHTS

- ◆ 16 DC-coupled wide-range input channels per unit, 4 independent grounds, record any type of signal (EEG/ECOG/ECG/EMG/EOG/...), connect various sensors, stack units for 32/48/64/... channels.
- ◆ 24-bit resolution with simultaneous sampling of all channels with up to 38.4 kHz, digital signal filtering and preprocessing, connect via USB 2.0.
- ◆ works with passive and with active electrodes, 8 digital trigger inputs/unit, 4 digital outputs/unit, new simplified synchronization of units.
- ◆ internal digital bandpass and notch filters, built-in calibration unit and impedance checking.
- ◆ easy configuration and setup via the software, high-speed online data processing for SIMULINK and for LabVIEW available, recommended by BCI2000
- ◆ driver package/API available
- ◆ CE-certified and FDA-approved medical device, safety class: II, conformity class: IIa, type of applied part: CF



Input channel properties

g.usBamp uses wide-range DC-coupled amplifier technology in combination with 24-bit sampling. The result is an input voltage range of +/- 250 mV with a resolution of < 30 nV! This means that any electrophysiological signal can be recorded directly without additional hardware. Neither high electrode offset voltage nor big artifacts resulting from electrical or magnetic stimulation will saturate the amplifier inputs. This feature is an important requisite for various artifact treatment and correction techniques. The use of digital filters avoids hardware-related variations between channels. g.tec's active electrode system can also be connected directly, as well as all of our sensors (e.g. GSR, skin temperature, blood pressure, oxygen saturation, respiration effort and airflow, pulse plethysmography, acceleration, limb movements, snoring sounds, and many more).



Accuracy and data quality

Each of the 16 analog to digital converters is operating at 2.4576 MHz. An oversampling of 64 times yields the internal sampling rate of 38.400 Hz (per channel and for all channels!). In addition, a powerful floating point Digital Signal Processor performs oversampling and real-time filtering of the biosignal data (between 0 Hz - 2.400 Hz). Therefore, a typical sampling frequency of 256 Hz yields an oversampling rate of 9.600. This results in a very high signal to noise ratio, which is especially critical when recording evoked potentials in the EEG or identifying small amplitude changes in high-resolution ECG recordings. You are measuring far below the noise-range of conventional amplifiers.

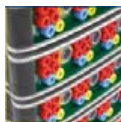

Add more channels or split systems

To set up a multi-channel system (32/48/64/... channels), g.usBamps can be stacked. Just add another 16 channels by connecting one more unit to the system. To assure 100% simultaneous sampling of all channels, a simple "SYNC cable" is used to interconnect the devices (via a plug in the rear side). Each input channel can be used for any type of signal (electrophysiological signals or external physiological or physical sensors). On the other hand, if you have a 64 channel system consisting of 4 amplifiers, you can split the system to have 4 units available.

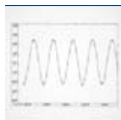

Test signal generation and calibration

The amplifier can generate an internal sinusoidal-, rectangular-, sawtooth or white-noise test signal. The amplitude and frequency of the signal can be modified to test the recording and analysis chain. An internal calibration unit periodically detects offset and gain values for each channel and uses these values for automatic internal correction. This technique provides topmost accuracy - especially needed for high resolution EEG and source derivation/localization.



Skin-electrode impedance

In order to obtain top-quality EEG recordings, the transition impedance between the skin and the electrode must be checked. The internal impedance testing unit measures the impedance for the individual electrodes and the results are displayed in the software. Bad electrodes can be identified easily and skin treatment and gel application can be performed during the impedance testing.



Software options

g.tec's philosophy is to provide a broad spectrum of software solutions for different groups of users (e.g. for engineers, researchers & scientists, physiologists, and medical staff, but also for software developers & programmers). From comfortable Windows-based recording software to MATLAB/SIMULINK and LabVIEW Highspeed Online-Processing environment and device drivers as well as APIs, you will find the appropriate tools for your application. Please see the list of related products/software below for more details. g.usBamp is also supported by some open source research communities such as OpenVibe and BCI2000.



Important information

As with all g.tec biosignal amplifiers, we give a full 5-years warranty on g.usBamp. g.usBamp is a safe certified medical device (CE and FDA) for research in humans, even for invasive recordings such as electrocorticography (ECoG). It must not be used for patient monitoring or determination of brain death. Medical diagnoses and decisions about treatment of diseases must not be based (solely) on results obtained with this device.



For ECoG

Ad-Tech grid electrode for ECoG for connecting with the g.usBamp

CONFIGURATIONS AND RELATED PRODUCTS

- ◆ **g.BCIsys:** Complete MATLAB-based Brain-Computer Interface development/research system » page 56
- ◆ **g.EEGsys:** Complete EEG research systems, ready-to-go installation » page 60
- ◆ **g.FEATUREmonitor:** Cerebral and autonomous function monitor & video-EEG » page 35
- ◆ **intendiX:** Patient-ready EEG-based spelling system and extendiX application control » page 61
- ◆ **g.TRIGbox:** Multimode trigger-conditioner-box » page 24
- ◆ **g.STIMbox:** Stimulation box to record and generate trigger signals » page 26
- ◆ **Electrodes and Electrode Systems:** Various active and passive electrodes for electrophysiological recordings » page 64
- ◆ **Sensors:** Various sensors for physiological and physical signals » page 74





HARDWARE

Product no.	Product name	Description
0216	g.USBamp	multi-modal biosignal amplifier (silver) with USB interface; 16 channels; 4 separated grounds, which guarantee no interference between the signals; bi-, unipolar recordings; can be assembled to build multi-channel systems; integrated electrode impedance check; integrated calibration unit; CE-certified medical device EN 60601-1 (IEC 60601-1); device driver for Microsoft Windows 7 32/64 bit; internal sampling frequency 38.4 kHz per channel; highest signal-to-noise ratio; standard 1.5 mm medical safety connectors; classification of device: safety class II, type of applied part CF, type of applied part BF if several amplifiers are connected, conformity class IIa; FDA approved; g.USBamp water-proof heavy duty case (5051); including g.USBamp USB cable (0282); standard color: silver, different colors on request, version 3.0 (SN: UB-XXXX.XX.XX)
0230	g.USBamp 8 channels	g.USBamp with 8 channels; 256Hz; no DIG I/O
0308	10 pin electrode connector box for U8	connector box for g.USBamp 8 channel version; 1,5 mm touch-proof connectors; 8 unipolar channels + 1 ground and 1 reference
0247	g.Power – g.USBamp	medical mains power supply for g.USBamp; 110/230 V; 50/60 Hz power line; single 5 V supply
0247a	g.Power – for 4 g.USBamps	medical mains power supply for g.USBamp; 110/230 V; 50/60 Hz power line; 4 x 5 V supply
0247b	g.Power – for 2 g.USBamps	medical mains power supply for g.USBamp; 110/230 V; 50/60 Hz power line; 2 x 5 V supply
0219a	ElectroCap-adapter cable to DSUB25 male for g.USBamp	adapter cable for 25 pin SUB-D 16 channels Electrocap for g.USBamp; standard: A: Screening
0223	shortcut jumper cable	shortcut cable for 2 channels; medical safety connector; can be daisy chained
0225	g.USBamp cable for short-cut function (SC)	3m cable with 3pin screw terminal
0251a	g.ACCUpack for g.USBamp	rechargeable battery pack, 12V and 5V, 4.5 Ah, for g.USBamp + adapter cable (0253a)
0252	charging device for g.ACCUpack	automatic charging device for battery pack g.ACCUpack (0251a/c), 110/230 V; 50/60 Hz power line, regional adapter for EU, USA, UK, CN/AUS
0253a	adapter cable g.ACCUpack/g.USBamp	adapter cable g.ACCUpack to g.USBamp, 2m
0281	g.USBamp synch cable (2x)	synchronisation cable for 2 g.USBamps; for serial numbers UA->UA or UB->UB
0283	g.USBamp synch cable (4x)	synchronization cable for 4 g.USBamps
0279	g.INTERsync	g.USBamp-interversion synchronization box between UA and UB; master is UB
0282	g.USBamp USB cable	connection of g.USBamp to USB-port of PC/notebook
0284	USB 2.0 Hub	with 4 connectors; for 4 g.USBamps
5051	g.USBamp water-proof heavy duty case	100 % water-proof heavy duty case for g.USBamp equipment
0277	trigger cable for g.USBamp UB	DIO break-out cable to DSUB15-female; for UB-xxxx.xx.xx
0278	adapter cable for trigger cable	DSUB15-male to 6x BNC-male adapter (including 6x BNC to CINCH adapter)
0275	trigger cable for g.USBamp UB	with open leads, for DIG I/O Trigger for UB-xxxx.xx.xx
0276	trigger cable for g.USBamp UB	DIG I/O 1 and DIG I/O 2 of g.USBamp UB-xxxx.xx.xx to D Sub 25 male (parallel port)
0307b	external trigger button UB	external trigger button for g.USBamp UB, with 2,5 m cable; 7 pin connector
3001a	business PC	high end business PC, software ready-to-go installation, with TFT screen; DVD writer; 2 GB RAM
3002	colorprinter	for the g.tec systems, Ink-jet
3003	business notebook	high end business notebook, software ready-to-go installation; DVD writer; 2 GB RAM
3012	medical isolation transformer	600 VA, EN/IEC 60601-1, 6 outputs
10040	medical device inspection	recurring medical device inspection (EN 62353:2008) for g.USBamp, g.HIamp or g.BSamp

Product no.	Product name	Description
6023	g.BCIsys16USB: complete BCI-research system, PC included	16 channels; consisting of: g.USBamp (biosignal amplifier, CE-certified, FDA approved, with power supply); SIMULINK HIGH-SPEED ONLINE Processing software (drivers and blockset for SIMULINK); g.RTanalyze (real-time software for biosignal parameter extraction); g.BSanalyze (base version + EEG-toolbox + Classify-toolbox for offline data processing, analysis and classification); fully equipped business PC (with software ready-to-go installation); bundle offer (0216+0282+5051+0247+0260+0111+0101+0102+0105+3001a); prerequisite MATLAB R2011a for OS English Win 32/64 (Windows 7), Signal Processing Toolbox, SIMULINK and Signal Processing Blockset
6029	g.BCIsys16USB, PC included ERD, SSVEP, P300	16 channels; consisting of: g.USBamp (biosignal amplifier, CE-certified, FDA approved, with power supply); SIMULINK HIGH-SPEED ONLINE Processing software (drivers and blockset for SIMULINK); g.RTanalyze (real-time software for biosignal parameter extraction); g.USBamp P300 model; g.USBamp Ping Pong model; g.USBamp SSVEP model and hardware; g.BSanalyze (base version + EEG-toolbox + Classify-toolbox for offline data processing, analysis and classification); fully equipped business PC (with software ready-to-go installation); bundle offer (6023+0139a+0140a+1303a); prerequisite MATLAB R2011a for OS English Win 32/64 (Windows 7), Signal Processing Toolbox, SIMULINK and Signal Processing Blockset
6024	g.BCIsys32USB: complete BCI-research system, PC included	32 channels; consisting of: g.USBamp (biosignal amplifier, double unit, CE-certified, FDA approved, with power supply); SIMULINK HIGH-SPEED ONLINE Processing software (drivers and blockset for SIMULINK); g.RTanalyze (real-time software for biosignal parameter extraction); g.BSanalyze (base version + EEG-toolbox + Classify-toolbox for offline data processing, analysis and classification); fully equipped business PC (with software ready-to-go installation); synchronisation cable; USB 2.0 Hub; bundle offer (2x0216+2x0282+2x5051+0247b+0260+0111+0101+0102+0105+3001a+0281+0284); prerequisite MATLAB R2011a for OS English Win 32/64 (Windows 7), Signal Processing Toolbox, SIMULINK and Signal Processing Blockset
6031	g.BCIsys32USB ERD, SSVEP, P300, PC included	32 channels; consisting of: g.USBamp (biosignal amplifier, double unit, CE-certified, FDA approved, with power supply); SIMULINK HIGH-SPEED ONLINE Processing software (drivers and blockset for SIMULINK); g.USBamp P300 model; g.USBamp Ping Pong model; g.USBamp SSVEP model and hardware; g.USBamp common spatial patterns; g.RTanalyze (real-time software for biosignal parameter extraction); g.BSanalyze (base version + EEG-toolbox + Classify-toolbox for offline data processing, analysis and classification); fully equipped business PC (with software ready-to-go installation); synchronisation cable; USB 2.0 Hub; bundle offer (6024+0139a+0140a+0142+1303a); prerequisite MATLAB R2011a for OS English Win 32/64 (Windows 7), Signal Processing Toolbox, SIMULINK and Signal Processing Blockset
6021	g.BCIsys64USB: complete BCI-research system, PC included	64 channels; consisting of: g.USBamp (biosignal amplifier, quadruple unit, CE-certified, FDA approved, with power supply); SIMULINK HIGH-SPEED ONLINE Processing software (drivers and blockset for SIMULINK); g.RTanalyze (real-time software for biosignal parameter extraction); g.BSanalyze (base version + EEG-toolbox + Classify-toolbox for offline data processing, analysis and classification); fully equipped business PC (with software ready-to-go installation); synchronisation cable; USB 2.0 Hub; bundle offer (4x0216+4x0282+4x5051+0247a+0260+0111+0101+0102+0105+3001a+0283+0284); prerequisite MATLAB R2011a for OS English Win 32/64 (Windows 7), Signal Processing Toolbox, SIMULINK and Signal Processing Blockset
6061	g.FEATUREmonitor, Neonatal ICU EEG/HRV-monitor, PC included	complete biosignal processing/observation package; consisting of: g.USBamp (16 channel biosignal amplifier, CE-certified, FDA approved, with power supply); g.Recorder + camera and parameter-observation software (CFM, heart-rate, heart-rate variability, compressed spectral array); offline data visualization; fully equipped business PC (with software ready-to-go installation); color printer; trolley for research package; bundle offer (0216+0282+5051+0247+0167a+0287+0132+3001a+3002+7020)
6062	g.FEATUREmonitor, Neonatal research ICU EEG/HRV-monitor, NB included	complete biosignal processing/monitoring package; consisting of: g.USBamp (16 channel biosignal amplifier, CE-certified, FDA approved, with power supply); g.Recorder + camera and parameter-observation software (CFM, heart-rate, heart-rate variability, compressed spectral array); g.BSanalyze (base version, CFM Toolbox and ECG part I Toolbox) for offline ECG and CFM analysis; fully equipped business notebook (with software ready-to-go installation); color printer; trolley for research package; bundle offer (0216+0282+5051+0247+0167a+0287+0132+0101+0104a+0115+3003+3002+7020); prerequisite MATLAB R2011a for OS English Win 32/64 (Windows 7), Signal Processing Toolbox
6070	g.EEG16sys, complete portable EEG recording/analysis system, NB included	consisting of: g.USBamp (16 channel biosignal amplifier, CE-certified, FDA approved, with power supply); g.Recorder + camera; g.BSanalyze (base version) for offline data visualization/processing and EEG-Toolbox for advanced EEG analysis; fully equipped business notebook (with software ready-to-go installation); bundle offer (0216+0282+5051+0247+0167a+0287+0101+0102+3003); prerequisite MATLAB R2011a for OS English Win 32/64 (Windows 7), Signal Processing Toolbox
6080	g.EEG32sys, complete EEG recording/analysis system, PC included	consisting of: g.USBamp (32 channel biosignal amplifier, CE-certified, FDA approved, with power supply); g.Recorder; g.BSanalyze (base version) for offline data visualization/processing and EEG-Toolbox for advanced EEG analysis; fully equipped business PC (with software ready-to-go installation); synchronisation cable; USB 2.0 Hub; bundle offer (2x0216+2x0282+2x5051+0247b+0167a+0287+0101+0102+3001a+0281+0284); prerequisite MATLAB R2011a for OS English Win 32/64 (Windows 7), Signal Processing Toolbox
6090	g.EEG64sys, complete EEG recording/analysis system, PC included	consisting of: g.USBamp (64 channel biosignal amplifier, CE-certified, FDA approved, with power supply); g.Recorder; g.BSanalyze (base version) for offline data visualization/processing and EEG-Toolbox for advanced EEG analysis; fully equipped business PC (with software ready-to-go installation); synchronisation cable; USB 2.0 Hub; bundle offer (4x0216+4x0282+4x5051+0247a+0167a+0287+0101+0102+3001a+0283+0284); prerequisite MATLAB R2011a for OS English Win 32/64 (Windows 7), Signal Processing Toolbox
6028	g.tec BCI2000 bundle offer with g.USBamp, NB included	consisting of: g.USBamp (16 channel biosignal amplifier, CE-certified, FDA approved, with power supply); water-proof heavy duty case; USB cable; fully equipped business notebook; C API and BCI2000 driver, BCI2000 driver package; bundle offer (0216+5051+0282+0247+3003+0263a)
6032	RehaBCI, PC included	32 channels; consisting of: g.BCIsys32USB; g.VRSys; g.GAMMAbundle for g.USBamp CSP; g.UDPInterface for communication between the PCs; g.USBamp common spatial patterns model; bundle offer; (6024+0299+1111b+0264+0299)
6037	g.USBamp CARDIObundle, PC included	system for ECG and blood pressure recordings; consisting of: g.USBamp (biosignal amplifier, CE-certified, FDA approved, with power supply); g.GAMMAbox (electrode driver box for 16 channels); g.GAMMAconnector; g.CNAPsensor (non invasive continuous blood pressure measurement); g.GAMMAclip, g.GAMMAclipGND, g.GAMMAclipREF; disposable Ag/AgCl electrodes; g.USBamp SIMULINK HIGH SPEED ONLINE PROCESSING (drivers and blocksets for SIMULINK); g.BSanalyze Base version, ECG I & II Toolboxes; fully equipped business PC (with software ready-to-go installation); bundle offer (0216, 1016c, 1019a, 2044a, 12x1024, 2x1025, 2x1047, 10x1032, 0260a, 0101, 0104a, 0104b, 3001a)

University/education prices available

SOFTWARE OPTIONS

Product no.	Product name	Description
0167a	g.Recorder for g.USBamp	fully GUI-based (graphical user interface); comfortable biosignal visualization and storage; full control of the amplifier and header; real-time compressed spectral array; heart-rate, heart-rate variability; webcam; single place licence; prerequisite OS English Win 32/64 (Windows 7)
0132	g.FEATUREmonitor	multi-channel and multi-modal (cerebral function) biosignal parameter observation software; prerequisite: g.Recorder (0167) ; single place licence
0260a	g.USBamp SIMULINK HIGH-SPEED ONLINE Processing	SIMULINK driver and blockset modules; highly optimized hardware-interrupt controlled device driver; allowing data processing with the maximum system speed; supports real-time processing of the biosignal data; calibration block; impedance measurement block; signal analysis blocks; single place licence; prerequisite MATLAB R2011a for OS English Win 32/64 (Windows 7), SIMULINK and Signal Processing Blockset
0168a	g.USBamp LabVIEW High-Speed Online Processing	LabVIEW drivers and virtual instrument modules; highly optimized hardware-interrupt controlled device driver; allows data processing with the maximum system speed; supports real-time processing of biosignal data, virtual instruments for calibration and impedance check; requires LabVIEW 8.6 or higher; prerequisite OS English Win 32/64 (Windows 7)
0291 	g.EYTracking Interface for SIMULINK	read eyetracking information into Simulink; single place licence; prerequisite MATLAB R2011a for OS English Win 32 (Windows 7), SIMULINK
0139a	g.USBamp P300 model	8-channel P300 based speller; prerequisite: SIMULINK HIGH-SPEED ONLINE Processing (0260a)
0140a	g.USBamp Ping Pong model	2 subject and 4-channel motor imagery based game; prerequisite: SIMULINK HIGH-SPEED ONLINE Processing (0260a)
0141a	g.USBamp SSVEP BCI model	8-channel 8 channel SSVEP based control; prerequisite SIMULINK HIGH-SPEED ONLINE Processing for g.USBamp, g.RTanalyze based speller; prerequisite: SIMULINK HIGH-SPEED ONLINE Processing (0260a)
1303a	SSVEP model and Hardware for g.USBamp	bundle for SSVEP based robot control; consists of g.USBamp SSVEP BCI model, g.SSVEPbox for stimulation, g.STIMbox to run g.SSVEPbox and small robot with bluetooth interface; prerequisite SIMULINK HIGH SPEED ONLINE processing for g.USBamp, g.BSanalyze Base, EEG & Classify Toolboxes, g.RTanalyze; (0141a, 1300, 1302, 1501)
0142	g.USBamp common spatial patterns	Simulink model to calculate CSPs of 27 electrodes, tutorial; prerequisite: SIMULINK HIGH-SPEED ONLINE Processing (0260a)
0111 	g.RTanalyze	real-time EEG, ECG, respiration, galvanic skin response and biosignal processing blockset under SIMULINK; real-time algorithms; single place licence; prerequisite MATLAB R2011a for OS English Win 32/64 (Windows 7), SIMULINK
0261	g.USBamp API for MATLAB	MATLAB programming driver package for g.USBamp; single place licence; prerequisite MATLAB R2011a for OS English Win 32 (Windows 7), Data Acquisition Toolbox
0263	g.USBamp C API	application programming interface (API) for user specific application (eg. developed in C/C++); single place licence; prerequisite OS English Win 32/64 (Windows 7)
0169a	Linux API for g.USBamp	driver software package for g.USBamp; full access to recording buffer; for user specific applications on the PC; single place licence; prerequisite Ubuntu Linux 10.x, 32bit
0263a	g.USBamp C API + BCI2000	application programming interface (API) for user specific application (eg. developed in C/C++); BCI2000 driver, BCI2000 software package; single place licence; prerequisite OS English Win 32/64 (XP or later)

 University/education prices available





SPECS

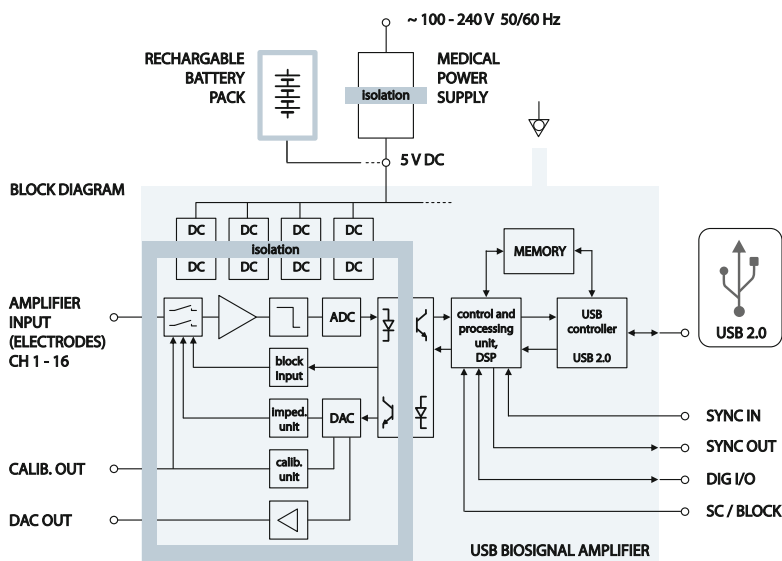

- Sensitivity: < 30 nV (LSB) - ± 250 mV
- Amplifier type: real DC coupled
- 16 x ADC: 24 bit (38.4 kHz internal sampling per channel)
- 2 x DAC: 12 bit
- Input channels: 16 mono- / 8 bi-polar (per device, software-selectable)
- Noise level: < 0.3 µV RMS (0.1 - 10 Hz)
- Input impedance: > 100 MOhm
- Input connectors: standard safety connectors and system connectors
- Weight: 1000 g
- Size: 197 x 155 x 40 mm
- Applied part: type CF
- Safety class: II
- Directive of medical products: 93/42/EWG
- Standards: EN60601-1: 1996 (+A1 +A2 +A12 +A13)
EN60601-2-26: 2004
EN60601-1-2: 2003
EN60601-2-25 +A1: 2001
EN60601-2-40: 1998



g.ACCUpack

0251a



g.INTERsync

0279



trigger cable

0276

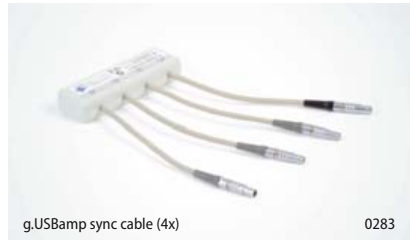

g.USBamp sync cable (4x)

0283



g.USBampGAMMAconnector

1019a

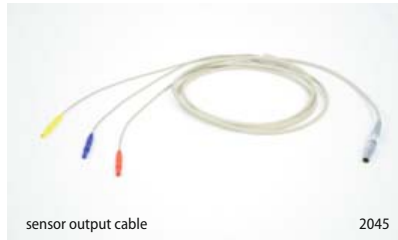

sensor output cable

2045



Fast Forward Award
SIF

g.BSamp
BIO SIGNAL AMPLIFIER

Stand-alone analog biosignal amplifier

The g.tec biosignal amplifier is a basic signal-conditioning tool to establish biosignal data acquisition and real-time analysis from MATLAB and SIMULINK. Its user-selectable multi-channel modules allow the simultaneous recording of EEG, EMG, EOG and ECG. The stand-alone amplifier system can be equipped with 8 or 16 channels, or it can be stacked to have a 32-, 48-, or 64- channel system. The modules are designed with bipolar inputs in order to perform not only referenced recordings, but also true bipolar recordings and analyses.

Filter, sensitivity and notch settings are user selectable. You can combine the g.BSamp with the

g.EEGcap and the g.GAMMAcap, and choose from a huge range of possible electrodes.

g.BSamp represents the optimal equipment for research in the field: from cars to aeroplanes and/or in vivo training procedures as well as from research to rehabilitation. It has an operation time of 8-10 hours with the battery supplied so that even time consuming trainings or long field investigations are warranted. For use in the lab a medical mains receiver is available.

Standard settings: LP: 100 Hz/1kHz; HP: 0.5/2 Hz; Sensitivity: +/- 500 uV/5mV; 50(60) Hz notch on/off

PRODUCT HIGHLIGHTS

- ◆ multi-modal amplifier system (EEG, EMG, EOG & ECG)
- ◆ +/- 5V analog output signal range
- ◆ 8 or 16 bipolar/real differential input channels
- ◆ user selectable filter and sensitivity settings via robust DIP switches
- ◆ portable due to available battery supply
- ◆ compatible with many other user-specific systems
- ◆ designed for EEG, EMG, EOG and ECG data acquisition
- ◆ CE certified medical device for use in humans according to medical normative EN 60601-1 (IEC 60601-1)

HARDWARE COMPONENTS

Product no.	Product name	Description
0205a	g.BSamp, 8 channels (50 Hz)	biosignal amplifier for EEG, ECG, EMG, EOG or custom signals; 8 channels uni-/bipolar; analog output; electronic handbook; CE-certified; 2 independent grounds; LP: 100 Hz/1kHz, HP: 0,5/2 Hz; Sensivity: 500 µV/5 mV, 50 Hz Notch, incl. jumper cable (0215)
0201a	g.BSamp, 16 channels (50 Hz)	biosignal amplifier for EEG, ECG, EMG, EOG or custom signals; 16 channels uni-/bipolar; analog output; electronic handbook; CE-certified; 2 independent grounds; LP: 100 Hz/1kHz, HP: 0,5/2 Hz; Sensivity: 500 µV/5 mV, 50 Hz Notch, incl. jumper cable (0218)
0205b	g.BSamp, 8 channels (60 Hz)	biosignal amplifier for EEG, ECG, EMG, EOG or custom signals; 8 channels uni-/bipolar; analog output; electronic handbook; CE-certified; 2 independent grounds; LP: 100 Hz/1kHz, HP: 0,5/2 Hz; Sensivity: 500 µV/5 mV, 60 Hz Notch, incl. jumper cable (0215)
0201b	g.BSamp, 16 channels (60 Hz)	biosignal amplifier for EEG, ECG, EMG, EOG or custom signals; 16 channels uni-/bipolar; analog output; electronic handbook; CE-certified; 2 independent grounds; LP: 100 Hz/1kHz, HP: 0,5/2 Hz; Sensivity: 500 µV/5 mV, 60 Hz Notch, incl. jumper cable (0218)
0244	g.Power – g.BSamp	medical mains power supply for g.BSamp, 110/230 V, 50/60 Hz power line, single 12 V supply
0231	g.16sys	coupling box for 16 analog channels; 8 digital I/O channels; 2 DA channels; + 5 V supply at front side; full access to analog and digital signals via cinch sockets; EMI-shielded
0235	g.80sys	coupling box for 80 analog channels; 24 digital I/O channels; 2 DA channels; +5 V supply at front side; full access to 16 analog and 8 digital signals via cinch sockets; EMI-shielded
0214	BNC adapter 8 channels	adapter SUB-D to BNC connector, 8 channels
0217	BNC adapter 16 channels	adapter SUB-D to BNC connector, 16 channels
0219c	ElectroCap-adapter cable	adapter cable for 25 pin SUB-D 16 channel Electrocap for g.BSamp; standard: A: Screening
0251c	g.ACCUpack for g.BSamp	rechargeable battery pack, 12V and 5V, 4.5 Ah, for one g.BSamp; adapter cable (0253c)
0252	charging device for g.ACCUpack	automatic charging device for battery pack g.ACCUpack (0251a/c), 110/230 V; 50/60 Hz power line, regional adapter for EU, USA, UK, CN/AUS
0253c	adapter cable g.ACCUpack/g.BSamp	adapter cable g.ACCUpack to g.BSamp, 2 m
3012	medical isolation transformer	600 VA, EN/IEC 60601-1, 6 outputs
10040	Medical device inspection	recurring medical device inspection (EN 62353: 2008) for g.USBamp or g.BSamp

SOFTWARE OPTIONS

Product no.	Product name	Description
0509	g.Recorder, 80 channels, 16 bit	data acquisition system and software; 80 analog channels; 8 digital I/Os, 16-bit ADC-card; g.80sys (0235) for 16 analog and 8 digital I/Os; connector box to 64 analog channels; full access to analog and digital signals; SCSI cables; electronic handbook; without PC; including video camera and g.Recorder (0167c); single place licence; prerequisite OS English Win 32/64 (Windows 7)
0505	g.Recorder, 32 channels, 16 bit	data acquisition system and software; 32 analog channels, 8 digital I/Os; 16-bit ADC-card; g.80sys (0235) for 16 analog and 8 digital I/Os; connector box to 16 analog channels; full access to analog and digital signals; SCSI cables, electronic handbook; without PC; including video camera and g.Recorder (0167c); single place licence; prerequisite OS English Win 32/64 (Windows 7)
0501	g.Recorder, 16 channels, 16 bit	data acquisition system and software; 16 analog channels; 8 digital I/Os; 16 bit ADC-card; g.16sys (0231); full access to analog and digital signals; SCSI cables; electronic handbook; without PC; including video camera and g.Recorder (0167c); single place licence; prerequisite OS English Win 32/64 (Windows 7)
0167c	g.Recorder for g.BSamp	fully GUI-based (graphical user interface); comfortable biosignal visualization and storage; full control of the amplifier and header; real-time compressed spectral array; heart-rate, heart-rate variability; webcam; single place licence; prerequisite OS English Win 32/64 (Windows 7)
0260c	g.BSamp SIMULINK HIGH-SPEED ONLINE Processing	SIMULINK driver and blockset modules; highly optimized hardware-interrupt controlled device driver; allowing data processing with the maximum system speed; supports real-time processing of the biosignal data; signal analysis blocks; single place licence; prerequisite MATLAB R2011a for OS English Win 32/64 (Windows 7), SIMULINK and Signal Processing Blockset
0132	g.FEATUREmonitor	multi-channel and multi-modal (cerebral function) biosignal parameter observation software; prerequisite: g.Recorder (0167) ; single place licence
0264	g.UDPinterface	data exchange with network connection between Simulink/MATLAB on different PCs (eg. BCI, VR, XVR, ...); single place licence; prerequisite MATLAB R2011a for OS English Win 32/64 (Windows 7), SIMULINK
0111	g.RTanalyze	real-time EEG, ECG, respiration, galvanic skin response and biosignal processing blockset under SIMULINK; real-time algorithms; single place licence; prerequisite MATLAB R2011a for OS English Win 32/64 (Windows 7), SIMULINK
0291	g.EYEtracking Interface for SIMULINK	read eyetracking information into Simulink; single place licence; prerequisite MATLAB R2011a for OS English Win 32 (Windows 7), SIMULINK
University/education prices available		



GEWINN
AWARD FOR
INNOVATION

Wireless biosignal acquisition system in your pocket

g.MOBilab+ is the perfect tool for recording multi-modal biosignal data on a standard PC or notebook. This allows investigation of brain-, heart-, and muscle- activity, eye movement, respiration, galvanic skin response, pulse and other body signals. g.MOBilab+ is available in two versions: the 8 channel EEG and the multi-purpose version. A switch can be connected for external triggering of the data.

g.MOBilab+ is equipped with low-noise biosignal amplifiers and a 16-bit A/D converter (256 Hz) which guarantees excellent data quality and a high signal-to-noise ratio. For sophisticated data analyses, g.MOBilab-data can be imported directly into g.BSanalyze, the toolbox for advanced biosignal processing and analyses. Data can also be converted into ASCII-format for other programs like MS-Excel or foreign toolboxes.

PRODUCT HIGHLIGHTS

- ◆ acquire EEG, ECG, EOG, EMG and other signals even outside your lab
- ◆ on-line visualization and storage of up to 16 channels on a PC or a notebook
- ◆ various software solutions available (driver/API, recording software, MATLAB/SIMULINK/LabVIEW, ...)
- ◆ transmit online biosignal data wirelessly via bluetooth 2.0 to a PC or notebook
- ◆ log data directly on an internal flash card memory (Mini-SD card)
- ◆ integrate the device into your real-time system under SIMULINK (BCI, neuro-, biofeedback)

TECHNICAL DETAILS AND SPECIFICATIONS

g.MOBILab+ (8-channel EEG version)	EEG Channels: 8, Filters: 0.5 - 100 Hz, Sensitivity: 500 μ V (monopolar), no additional analog inputs		
g.MOBILab+ (multi-purpose version)	EEG Channels: 2 Filters: 0.5 - 100 Hz Sensitivity: 500 μ V (bipolar)	EEG/EOG Channels: 2 Filters: 0.01 - 100 Hz Sensitivity: 2 mV (bipolar)	ECG/EMG Channels: 2 Filters: 0.5 - 100 Hz Sensitivity: 5mV (bipolar)
Analog inputs (multi-purpose)	Channels: 2, Filters: DC-100 Hz, Sensitivity: +/- 250 mV (monopolar)		
Additional inputs/outputs	4 digital inputs/outputs, 4 digital inputs (TTL), +5V		
Power supply	4 standard AA batteries or accumulators (25 - 100 hours operation time, depending on mode)		
Data acquisition	ADC with 16 Bit and 256 Hz/channel, serial interface (RS232), Bluetooth 2.0 / class I (+)		
Standard	Manufactured according to IEC 60601-1, for research application, no medical device		
Internal storage card	Micro-SD flash memory card (up to 2 GB), accessible via the battery compartment		
Weight	360 gram (including batteries)		
Dimension	155 mm x 100 mm x 40 mm		

CONFIGURATIONS AND RELATED PRODUCTS

- ◆ **g.BCIsys:** Complete MATLAB-based Brain-Computer Interface development/research system ▶▶ page 56
- ◆ **g.EEGsys:** Complete EEG research systems, ready-to-go installation ▶▶ page 60
- ◆ **g.FEATUREmonitor:** Cerebral and autonomous function monitor & video-EEG ▶▶ page 35
- ◆ **intendiX:** Patient-ready EEG-based spelling system and extendiX application control ▶▶ page 61
- ◆ **g.TRIGbox:** Multimode trigger-conditioner-box ▶▶ page 24
- ◆ **g.STIMbox:** Stimulation box to record and generate trigger signals ▶▶ page 26
- ◆ **Electrodes and Electrode Systems:** Various active and passive electrodes for electrophysiological recordings ▶▶ page 64
- ◆ **Sensors:** Various sensors for physiological and physical signals ▶▶ page 74



HARDWARE COMPONENTS

Product no.	Product name	Description
5033	g.MOBilab+ multi-purpose version	2 EEG; 2 EEG/EOG; 2 ECG/EMG bipolar channels; 2 analog inputs; 4 x digital I/O + 4 x digital IN; battery supplied with 4 AA type batteries; wireless signal transmission; streaming onto Mini-SDcard; 2 GB Mini-SDcard (3015); electronic handbook; Bluetooth dongle (3016)
5002	5-lead ECG/EMG patient cable for g.MOBilab+ multi-purpose version	for 2 ECG/EMG bipolar channels for g.MOBilab+, for use with disposable electrodes; with clip leads
5003	9-pin EEG/EOG connector box for g.MOBilab+ multi-purpose version	for 2 EEG and 2 EEG/EOG bipolar channels, for g.MOBilab+; 1.5 mm touch-proof connectors
5003c	6-pin ECG/EMG connector box for g.MOBilab+ multi-purpose version	for ECG/EMG recordings for g.MOBilab+; 1.5 mm touch-proof connectors; 2 bipolar channels + 2 grounds
5052	6-pin analog input connector box for g.MOBilab+ multi-purpose version	for analog signal recordings, for g.MOBilab+; 1.5 mm touch-proof connectors; 2 unipolar channels + 2 grounds
5603	g.MOBilab+ 8 channel EEG version	8 unipolar EEG channels; 4 x digital I/O + 4 x digital IN; battery supplied with 4 AA type batteries; wireless signal transmission; streaming onto Mini-SDcard; 2 GB Mini-SDcard; electronic handbook; Bluetooth dongle (3016)
5601	10-pin connector cable to DSUB25 male for g.MOBilab+ EEG version	for EEG recordings with ribbon cable electrode caps, specify channel pinout at order!
5602	10-pin EEG electrode connector box for g.MOBilab+ EEG version	for EEG recordings, for g.MOBilab+; 1.5 mm touch-proof connectors; 8 unipolar channels + 1 ground + 1 reference
3012	medical isolation transformer	600 VA, REO-MED, 6 outputs
3015a	micro SD-card, 2 GB	for g.MOBilab+
3016	bluetooth dongle for g.MOBilab+	USB; for notebook/PC
3017	PC RS232 data cable	g.MOBilab+ to PC serial cable incl. adapter for USB port
5001a	external trigger button	for g.MOBilab+; 4 pin connector
5004	4 pin connector (TRIG)	with 3 m cable, with open leads
5005	10 pin connector (AIN/DIGITAL I/O)	with 3 m cable, with open leads
5006	8 pin connector (ECG/EMG)	with 3 m cable, with open leads
5007	10 pin connector (EEG)	with 3 m cable, with open leads
5014a	paradigm LED box for g.MOBilab+	10 pin connector
5050	g.MOBilab+ water-proof heavy duty case	100% water-proof heavy duty case for the g.MOBilab+ equipment

SOFTWARE OPTIONS

Product no.	Product name	Description
0167b	g.Recorder for g.MOBilab+	fully GUI-based (graphical user interface); comfortable biosignal visualization and storage; full control of the amplifier and header; real-time compressed spectral array; heart-rate, heart-rate variability; webcam; single place licence; prerequisite OS English Win 32/64 (Windows 7)
0132	g.FEATUREmonitor	multi-channel and multi-modal (cerebral function) biosignal parameter observation software; prerequisite: g.Recorder (0167); single place licence
5011	g.MOBilab+ C API	driver software package for g.MOBilab+; full access to recording buffer; for user specific applications on the PC; single place licence; prerequisite OS English Win 32/64 (Windows 7)
5011a	g.MOBilab+ C API + BCI2000	driver software package for g.MOBilab+; full access to recording buffer; for user specific applications on the PC; BCI2000 driver, BCI2000 software package; single place licence; prerequisite OS English Win 32/64
5016	g.MOBilab+ API for MATLAB	MATLAB driver software package for g.MOBilab+; full access to the amplifier from MATLAB command window; for user specific applications under MATLAB; single place licence; prerequisite MATLAB R2011a for OS English Win 32 (Windows 7), Data Acquisition Toolbox
0169b	LINUX API for g.MOBilab+	driver software package for g.MOBilab+; full access to recording buffer; for user specific applications on the PC; single place licence; prerequisite Ubuntu Linux 10.x, 32bit
5012a	g.MOBilab+ SIMULINK HIGH-SPEED ONLINE Processing	SIMULINK driver and blockset modules; highly optimized hardware-interrupt controlled device driver; allowing data processing with the maximum system speed; supports real-time processing of the biosignal data; signal analysis blocks; single place licence; prerequisite MATLAB R2011a for OS English Win 32/64 (Windows 7), SIMULINK



SOFTWARE OPTIONS CONTINUED

Product no.	Product name	Description
0168b	g.MOBILab+ LabVIEW High-Speed Online Processing	LabVIEW drivers and virtual instrument modules; highly optimized hardware-interrupt controlled device driver; allows data processing with the maximum system speed; supports real-time processing of biosignal data, virtual instruments for calibration and impedance check; requires LabVIEW 8.6 or higher; prerequisite OS English Win 32/64 (Windows 7)
0291	g.EYEtracking Interface for SIMULINK	read eyetracking information into Simulink; single place licence; prerequisite MATLAB R2011a for OS English Win 32 (Windows 7), SIMULINK
0139b	g.MOBILab+ P300 model	8-channel P300 based speller; prerequisite: SIMULINK HIGH-SPEED ONLINE Processing
0141b	g.MOBILab+ SSVEP BCI model	8 channel SSVEP based control; prerequisite SIMULINK HIGH-SPEED ONLINE Processing for g.MOBILab
1303b	SSVEP model and Hardware for g.MOBILab	bundle for SSVEP based robot control; consists of g.MOBILab+ SSVEP BCI model, g.SSVEPbox for stimulation, g.STIMbox to run g.SSVEPbox and small robot with bluetooth interface; prerequisite SIMULINK g.MOBILab+ HIGH SPEED ONLINE processing, g.BSanalyze Base, EEG & Classify Toolboxes, g.RTanalyze; (0141b, 1300, 1302, 1501)
0111	g.RTanalyze	real-time EEG, ECG, respiration, galvanic skin response and biosignal processing blockset under SIMULINK; real-time algorithms; single place license; prerequisite MATLAB R2011a for OS English Win 32/64 (Windows 7), SIMULINK
0264	g.UDPinterface	data exchange with network connection between Simulink/MATLAB on different PCs (eg. BCI, VR, XVR, ...); single place licence; prerequisite MATLAB R2011a for OS English Win 32/64 (Windows 7), SIMULINK
University/education prices available		

COMPLETE SOLUTIONS

Product no.	Product name	Description
6006	g.BCIsys8MOBILab+: BCI research system, 8 EEG, NB included	consisting of: g.MOBILab+ 8 channel EEG version + Mini SD-card 1 GB; 10-pin connector box; g.MOBILab Simulink High-Speed Online Processing software; g.RTanalyze (software for online biosignal parameter extraction); g.BSanalyze (Base version + EEG toolbox + Classify toolbox for offline data processing, analysis and classification); Bluetooth dongle; fully equipped business notebook (with software ready-to-go installation); cables; bundle offer (5603+3014+5602+5012a+0111+0101+0102+0105+3016+3003); prerequisite MATLAB R2011a for OS English Win 32/64 (Windows 7), Signal Processing Toolbox, SIMULINK and Signal Processing Blockset
6014	g.BCIsys8MOBILab+ SSVEP, P300, NB included	consisting of: g.MOBILab+ 8 channel EEG version + Mini SD-card 1 GB; 10-pin connector box; g.MOBILab Simulink High-Speed Online Processing software; g.MOBILab+ P300 model; g.MOBILab+ SSVEP model and hardware; g.RTanalyze (software for online biosignal parameter extraction); g.BSanalyze (Base version + EEG toolbox + Classify toolbox for offline data processing, analysis and classification); Bluetooth dongle; fully equipped business notebook (with software ready-to-go installation); cables; bundle offer (6006+0139b+1303b); prerequisite MATLAB R2011a for OS English Win 32/64 (Windows 7), Signal Processing Toolbox, SIMULINK and Signal Processing Blockset
6007	g.BCIsysMOBILab+: BCI research system, multi-purpose, NB included	consisting of: g.MOBILab+ multi-purpose version (4 EEG/EOG, 2 ECG/EMG, 2 analog inputs, digital I/Os) + Mini SD-card 1 GB; 9-pin connector box; g.MOBILab Simulink High-Speed Online Processing software; g.RTanalyze (software for online biosignal parameter extraction); g.BSanalyze (Base version + EEG toolbox + Classify toolbox for offline data processing, analysis and classification); Bluetooth dongle; fully equipped business notebook (with software ready-to-go installation); cables; bundle offer (5033+3014+5003+5012a+0111+0101+0102+0105+3016+3003); prerequisite MATLAB R2011a for OS English Win 32/64 (Windows 7), Signal Processing Toolbox, SIMULINK and Signal Processing Blockset
6008	g.EEGsys g.MOBILab+ multi-purpose version, NB included	consisting of: g.MOBILab+ (4 EEG/EOG, 2 ECG/EMG, 2 analog inputs, digital I/Os) + Mini SD-card 1 GB; 9-pin connector box; g.Recorder; g.BSanalyze (Base version + EEG toolbox for offline data processing); 5 lead ECG/EMG patient cable; Bluetooth dongle; fully equipped business notebook (with software ready-to-go installation); cables; bundle offer (5033+3014+5003+0167b+0101+0102+5002+3016+3003); prerequisite MATLAB R2011a for OS English Win 32/64 (Windows 7), Signal Processing Toolbox
6009	g.EEGsys g.MOBILab+ 8 channel EEG version, NB included	consisting of: g.MOBILab+ 8 channel EEG version + Mini SD-card 1 GB; 10-pin connector box; g.Recorder; g.BSanalyze (Base version + EEG toolbox for offline data processing); Bluetooth dongle; fully equipped business notebook (with software ready-to-go installation); cables; bundle offer (5603+3014+5602+0167b+0101+0102+3016+3003); prerequisite MATLAB R2011a for OS English Win 32/64 (Windows 7), Signal Processing Toolbox
6011	g.BCIsys8MOBILab+: P300, 8 EEG, NB included	consisting of: g.MOBILab+ 8 channel EEG version + Mini SD card 1 GB; 10-pin connector box; g.MOBILab Simulink High-Speed Online Processing software; g.BSanalyze (Base version + EEG toolbox + Classify toolbox for offline data processing, analysis and classification); Bluetooth dongle; fully equipped business notebook (with software ready-to-go installation); cables; bundle offer for P300 experiments (5603+3014+5602+5012a+0101+0102+0105+3016+3003); prerequisite MATLAB R2011a for OS English Win 32/64 (Windows 7), Signal Processing Toolbox, SIMULINK and Signal Processing Blockset
6012	g.tec BCI2000 bundle offer with g.MOBILab+, NB included	consisting of: g.MOBILab+ EEG version + Mini SD card 1 GB; 10-pin connector; g.MOBILab+ C API + BCI2000 driver, BCI2000 software package; fully equipped business notebook (with ready to go installation); bundle offer (5603+3014+5602+5011a+3016+3003)
University/education prices available		



g.tec's multimodal trigger system

The g.TRIGbox is a device to generate trigger pulses from various sensors or input signals. Input and output lines are isolated from each other. The trigger outputs can be connected to digital or analog inputs of a data acquisition system (such as g.USBamp, g.Hlamp or g.MOBILab⁺).

Thus, g.TRIGbox provides exact detection and recording of almost any type of stimulation in your experimental paradigms. Its wide range of possible input

signals and sensors allows the use of various trigger sources such as sound card outputs, microphones, piezoelectric or inductive sensors, response buttons, various logic signals (TTL, C-MOS, ...) provided by external stimulators, visual markers from the computer monitor, LED indicators, flash lamps or slide projectors. The threshold levels are adjustable separately for each channel. 4 LEDs indicate the proper detection for each channel.

TECHNICAL DETAILS AND SPECIFICATIONS

Trigger output voltage	TTL +5 V , BSL 200 mV	Supply	9V battery or power supply
Input voltage (low level)	± 0.5 mV to ± 200 mV (4 inputs)	Current consumption	~ 40 mA
Input voltage (high level)	± 100 mV to ± 5 V (4 inputs)	Low battery indicator	~ 7 V
Trigger output duration	min. 20 ms	Isolation voltage	1.5 kV (input/output)

PRODUCT HIGHLIGHTS

- ◆ simply use PowerPoint for stimulus/paradigm setup and presentation
- ◆ > 1.5 kV isolation between trigger inputs and outputs
- ◆ use various trigger sources from visual, auditory, electrical or tactile stimulators
- ◆ connect to a data acquisition system, g.MOBILab+, g.Hlamp or g.USBamp
- ◆ compatible with many other user-specific systems
- ◆ use one encoded trigger channel for up to 16 different experimental conditions

HARDWARE

Product no.	Product name	Description
0274	g.TRIGbox	multimode trigger-conditioner-box, battery supplied; 3 x 4 trigger inputs for analog, optical and digital trigger signals; adjustable thresholds; LED indicators; 1 x analog encoded output; cable for 4 x trigger output included; for g.Hlamp HA-xxxx.xx.xx
0268a	g.Power for g.TRIGbox	medical mains power supply for g.TRIGbox (0274a/ub/b/c); 110/230 V; 50/60 Hz power line; single 9 V supply
0269	g.TRIGbox, push-button	bounce-free, to record subject responses, 1.8 m cable
0270	g.TRIGbox, optical trigger sensor	for screen marker or strobe lamp detection, 1.8 m cable
0271	g.TRIGbox, microphone	to trigger on acoustic events, 1.8 m cable

Electrical current stimulator and timing unit



The DS3 electrical current stimulator provides a precise constant current stimulus (up to 32mA) controllable in pulse duration and amplitude and this output comes from self-contained batteries. The DS3 also features a “clamp” or discharge circuit which discharges the output between stimuli, preventing a charge build up on the preparation. In other constant current devices this charge build up can lead to a loss of stimulus. The DS3 can be triggered by an external device such as the DG2A train/delay generator.

The DG2A timing unit has been designed for control of normal repetitive stimulation as well as for defining the Effective Refractory Period using a second, delayed pulse. This unit is especially useful as a frequency generator for use with the DS3 isolated stimulator which has its own pulse duration controls.

HARDWARE

Product no.	Product name	Description
1200	electrical current stimulator	variable amplitude (2 μ A to 32 mA) and pulse duration (20 μ s to 2 s), battery supplied; this stimulator is NOT approved for use on human subjects
1200a	electrical current stimulator	medical approved device according to IEC 60601-1
1201	timer for stimulator	frequency generator for electrical current stimulator (1200)

Receive digital trigger input information and send stimulation patterns to external stimulators



The g.STIMbox is used to generate and record trigger signals. Arbitrary paradigms can be programmed easily using the 16 digital outputs and are executed with high temporal precision. At the same time, trigger signals from external devices can be recorded using the 14 digital inputs of the device.

Therefore the g.STIMbox is an ideal extension for electrophysiological research systems which require additional digital input and output possibilities. The device provides versatile cinch connectors for 8 of the 16 outputs which can be used very conveniently, e.g. with LEDs for visual stimulation, to connect electrical stimulators or other devices triggered by 5V pulses. Compact devices like the g.SSVEPbox, which require

several output/input channels, are connected using the SUB-D ports of the device. The 14 digital inputs can be used to record signals from external devices. Here, again, 8 of the 14 digital inputs are implemented as cinch connectors. The g.STIMbox is connected to the recording computer via USB, offers synchronous and asynchronous operation modes, and comes with a C-application programming interface (API), a MATLAB-API and a SIMULINK-block.

Highly accurate stimulation frequencies can be defined and are calculated on the g.STIMbox (e.g. 10 Hz for SSVEP stimulation). Therefore a highly precise SSVEP stimulation as used for BCI experiments can be realized.

PRODUCT HIGHLIGHTS

- ◆ μ C controlled inputs and outputs for accurate timing
- ◆ Digital outputs can produce precisely-timed paradigms
- ◆ Digital inputs can be acquired and used within the recording system
- ◆ Direct control of inputs/outputs from a computer via USB
- ◆ 14 digital inputs (TTL) and 16 digital outputs (TTL)
- ◆ Digital outputs usable for tactile or visual stimulation
- ◆ C API, MATLAB API and Simulink drivers

HARDWARE

Product no.	Product name	Description
1302	g.STIMbox	stimulation box to record and generate trigger signals, 16 digital outputs and 14 digital inputs; C API, MATLAB API and Simulink driver; including external power supply unit and USB cable; prerequisite: MATLAB R2011a for OS English Win 32/64 (Windows 7), SIMULINK
1300	g.SSVEPbox	SSVEP stimulation box with 4 stimulation- and 4 training-LEDs, adjustable intensity; including connection cable to g.STIMbox; prerequisite g.STIMbox (1302)

g.[®]PAH
 PROGRAMMABLE
 ATTENUATOR &
 HEADPHONE BUFFER



Made in cooperation with
 the Otto-von-Guericke-University
 Magdeburg, Germany.

g.tec's programmable attenuator and headphone buffer for experimental audiology

g.PAH enables you to run EEG experiments with auditory stimulation for objective audiometry. The device is used to accurately attenuate a sound signal in steps of 1 dB. If the input signal is e.g. attenuated by 20 dB then the output signal amplitude is 1/10th of the input signal amplitude. Such an accurate control of damping is necessary in the field of objective audiometry. Sound signals generated e.g. by a CD player or PC/notebook soundcard are sent to g.PAH input. The device - controlled via a serial interface - attenuates the signals by the specified damping factors. The output sound signal is then sent to a standard

high-end head phone or speakers for audiometry and presented to the subject. The device is equipped with 2 separately controlled channels. The included software lets you adjust the attenuation for each channel per mouse-click. The protocol for the serial interface is described and lets you integrate the device into almost any experimental or routine setup.

The advanced design of g.PAH guarantees that the switching times between the gauges are in conformity with the standard EN 60645-1 for audiometers.

PRODUCT HIGHLIGHTS

- ◆ accurate control of damping
- ◆ 2 separately controlled channels
- ◆ integrate the device into almost any setup
- ◆ conforms to the standard EN 60645-1 for audiometers
- ◆ run EEG experiments with accurate auditory stimulation

TECHNICAL DETAILS AND SPECIFICATIONS

Attenuation range	0 ... 120 dB	Input signal range	± 5V peak	Line out impedance	200 Ohm
Attenuation resolution	1 dB	Total harmonic dist.	0.003% (1 kHz)	Headphone impedance	40 Ohm
Attenuation accuracy	0.05 dB	SNR	112 dB (20 Hz...30 kHz)	Power Supply	220/240 V or 110/120 V
Channel separation	> 110 dB	Input impedance	200 kOhm		

HARDWARE

Product no.	Product name	Description
0600	g.PAH, attenuator/head phone buffer 2-channel (230V)	programmable 2 channel head phone buffer; bandwidth 10 Hz - 150 kHz; programmable damping factor in 1 dB steps; serial interface cable; left/right channel; input: 2 cinch sockets; output: 2 standard phone jacks 6.3 mm, line out: 2xBNC; built-in (230V/50Hz) supply
0605	g.PAH, attenuator/head phone buffer 2-channel (110V)	programmable 2 channel head phone buffer; bandwidth 10 Hz - 150 kHz; programmable damping factor in 1 dB steps; serial interface cable; left/right channel; input: 2 cinch sockets; output: 2 standard phone jacks 6.3 mm, line out: 2xBNC; built-in (110V/60Hz) supply

Real-time eye movement data under SIMULINK high-speed online processing

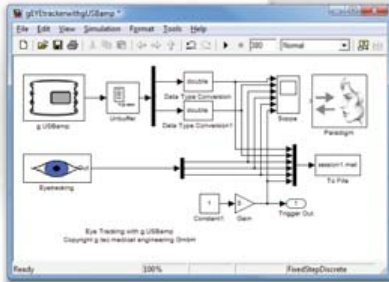

The ViewPoint Eyetracking system is available as monocular or binocular option. The eyetracking system can be worn without discomfort for long periods. Easily adjustable in size and compatible with glasses, this design is well received by subjects, who mostly dislike helmet style systems.

The eyetracker is fixed on very lightweight glasses, and the device comes with one camera pointing to the eye and another camera pointing in the same direction as the subject's eye. This scene camera allows you to capture the environment.

Parallax error correction is provided in the binocular system for viewing distances different from the original calibration distance. The eye movement data is recorded at 60Hz.

The g.EYetracking Interface for SIMULINK allows you to acquire eye gaze and x-, y-coordinates of the eye together with biosignal data. The signals can be visualized, stored and analyzed in real-time in SIMULINK and off-line in MATLAB.



PRODUCT HIGHLIGHTS

- ◆ Parallax error correction provided in the binocular system
- ◆ Unlimited head movement
- ◆ Accuracy approximately 0.25° – 1.0° visual arc
- ◆ monocular or binocular options
- ◆ Record and view x-, y-eye-coordinates, velocity, pupil width, ocular torsion, fixation duration in SIMULINK simultaneously with biosignal data

HARDWARE

Product no.	Product name	Description
0288a	g.EYetracker Monocular (PC version)	Monocular EyeFrame SceneCamera system; prerequisite OS English Win 32 (XP or later)
0288b	g.EYetracker Monocular (NB version)	Monocular EyeFrame SceneCamera system; prerequisite OS English Win 32 (XP or later)
0289	g.EYetracker Binocular (PC version)	Binocular EyeFrame SceneCamera system; prerequisite OS English Win 32 (XP or later)
0290	g.EYetracker Ultra Precision Head Positioner	Light weight and portable. Stable viewing position or restriction of head movement. Designed to fit a wide range of face and head shapes and sizes.

SOFTWARE

Product no.	Product name	Description
0291 	g.EYetracking Interface for SIMULINK	read eyetracking information into Simulink; single place licence; prerequisite MATLABR2011a for OS English Win 32 (Windows 7), SIMULINK
 University/education prices available		

g.tec's miniaturized pre-amplifier



The g.tec 16-channel head-stages allow the recording of action potentials/spikes with g.USBamp. The boards are extremely small and lightweight and are connected via a very flexible cable to g.USBamp. This allows the animal to move with almost no restrictions. The electronic system has an extremely low noise level and very high input impedance for high quality recordings. The channels have very similar gain, and therefore a very high Common Mode Rejection Ratio is obtained. The head-stages can also be used for biosignal recordings like EEG or ECG in animals.

The head-stages are connected to the g.SPIKEsens power supply and filtering box that is connected to the g.USBamp. One g.SPIKEsens box supports up to 16 channels. Several head-stages can be used simultaneously. The g.SPIKEsens box filters the signal between 0.5 Hz and 6000 Hz. Voltage Noise Density at 1 kHz is only 10 nV/SQRT(Hz). Aggregation boards

can be used to interface the head-stages with different electrodes like twisted wires, silicon electrodes and/or multi-electrode arrays.

Micro-wires and micro-electrode arrays (MEAs) have high impedances and must be very stable on the animal's heads. Therefore, the electrodes are connected with a very flexible cable to the input of the head-stage amplifier that has very high input impedance. It is important that this input impedance is magnitudes higher than the electrode impedance to pick up the neural activity correctly. Then, operational amplifiers with precise gain are used to amplify the spikes and to drive the cable that connects the animal to the main recording system. The precise gain is especially important for a high common-mode rejection ratio (CMRR, 100 dB). The pre-amplifiers avoid also distortions in the signal such as power line interference, electromagnetic interference, and cable artifacts.

PRODUCT HIGHLIGHTS

- ◆ Extremely small board (16 channels: 23 mm × 23 mm)
- ◆ Low weight (<3 g)
- ◆ Aggregation boards help interface different electrodes types
- ◆ High quality neuronal activity recordings
- ◆ LED slot to support easier video tracking
- ◆ Very high signal-to-noise ratio

HARDWARE

Product no.	Product name	Description
1206	g.HEADstage (16 channels)	tiny amplifier for recording of action potentials; reduces cable artefacts; including 3 m low-noise cable to g.SPIKEsens Driver Box; with golden pin connector; 16 channels, not approved for use in humans
1203	g.SPIKEsens Driver Box	driver box for g.HEADstage; connection cable to g.USBamp
1220	g.SPIKEsensHEADstageconnector	connector cable between the g.USBamp (system connector) and the g.SPIKEsens Driver Box; 40 cm lead



g.VRsys
VIRTUALREALITY SYSTEM

Complete virtual reality setup for research – flexible, cost-efficient and powerful

g.VRsys is a complete Virtual Reality (VR) research system that consists of a VR PC running XVR for 3D simulations, a projection wall with a 3D projector, an optional tracker and 3D shutter glasses with infrared emitter. g.VRsys can also be combined with a physiological analysis system. The VR scenarios can be programmed easily with XVR and are shown with a standard Internet Explorer. Physiological signals can be logged simultaneously in MATLAB and can be analyzed in real-time to influence the VR.

The development of a complete Virtual Reality application is a complex activity that requires good knowledge of several time-critical tasks. Computer graphics, real-time physics and network programming are examples of fundamental building blocks that need to coexist in many modern Virtual Reality

systems. Each of these building blocks constitutes a research field on its own, and a vast literature exists on techniques and algorithms to address specific problems. Still, from a more high level perspective, a complex framework can only achieve optimal performance through tight integration and balanced design. The development of a Virtual Reality application can turn out to be a very lengthy and difficult process, where fundamental design choices and their implications should be carefully considered. The choice of the right tools is also very important, as common everyday practice shows how difficult is still to put together a successful and robust system.

g.tec hence designed together with VRMedia, a complete VR package that allows you easily run VR applications in your lab.

PRODUCT HIGHLIGHTS

- ◆ cost efficient VR system with 3D projections on a powerwall
- ◆ example code available for high-resolution 3D
- ◆ control VR scenarios with the BCI system
- ◆ programming environment for VR based on XVR
- ◆ connection to the g.tec's amplifiers possible: acquisition and analysis of biosignals such as EEG, ECG, EMG, EOG, GSR and respiration simultaneously with the VR simulation
- ◆ use VR to give highly immersive feedback e.g. for stroke BCI rehabilitation



XVR is a new technology to develop advanced multimedia content. It is focused mainly on 3D graphics and sound, but many forms of media are supported. XVR is a tiny ActiveX component developed by VRMedia. All you need to integrate an XVR content in a web page is a computer with a decent video card installed and Internet Explorer.

The first time you access a web page that uses XVR, you will be asked to install it, like any other ActiveX plug-in (Adobe Flash, for example). A simple mouse-click and it's done. It's that simple. The XVR ActiveX control weights only 535 KB and is been developed from the ground up with three goals in mind: efficiency, flexibility, and scalability.

COMPLETE SOLUTIONS

Product no.	Product name	Description
0298	g.VRsys (small screen), PC included	consisting of 3D stereo compatible projector (100 Hz); rear projection wall – size in cm (viewable area in cm): 240x180 (220x160); 3D shutter glasses with infrared emitter; PC with high performance 3D stereo compatible graphic card with an interface for the infrared emitter; XVR – 3D programming language (XVR needs Microsoft Windows and Internet Explorer); professional XVR development environment; connection (to g.tec amplifiers) through UDP with g.UDPinterface (0264) - not included; prerequisite OS English Win 32/64 (Windows 7)
0299	g.VRsys (medium screen), PC included	consisting of 3D stereo compatible projector (100 Hz); rear projection wall – size in cm (viewable area in cm): 320x245 (300x225); 3D shutter glasses with infrared emitter; PC with high performance 3D stereo compatible graphic card with an interface for the infrared emitter; XVR – 3D programming language (XVR needs Microsoft Windows and Internet Explorer); professional XVR development environment; connection (to g.tec amplifiers) through UDP with g.UDPinterface (0264) - not included; prerequisite OS English Win 32/64 (Windows 7)
0300	g.VRsys (large screen), PC included	consisting of 3D stereo compatible projector (100 Hz); rear projection wall – size in cm (viewable area in cm): 450x335 (430x315); 3D shutter glasses with infrared emitter; PC with high performance 3D stereo compatible graphic card with an interface for the infrared emitter; XVR – 3D programming language (XVR needs Microsoft Windows and Internet Explorer); professional XVR development environment; connection (to g.tec amplifiers) through UDP with g.UDPinterface (0264) - not included; prerequisite OS English Win 32/64 (Windows 7)
0306	Head and Hand Tracker	The PC-Tracker is a 6 degree of freedom (6-DOF) motion tracking system utilizing hybrid technology of inertial and ultrasonic tracking. Immune to metallic, acoustic and optical interference. Two tracking devices: head and hand tracking; prerequisite OS English Win 32/64 (Windows 7)

Accessories

IMPEDANCE MEASUREMENT SYSTEM AND TEST SIGNAL GENERATOR



Product no.	Product name	Description
0241	g.Zcheck	electrode impedance measurement system; 10 Hz, portable; built-in 5 kOhm test impedance; 9V battery supplied
0242	g.SIGgen	sine-wave generator; uV-mV; 10 Hz; portable; 9V battery supplied

SHORTCUT / JUMPER CABLES



Product no.	Product name	Description
0223	shortcut jumper cable for 2 channels	shortcut cable for 2 channels medical safety connector; can be daisy chained
0224b	shortcut cables for 4 channels	for 3 medical safety sockets of 1.5 mm + 1 jumper connector; highly flexible cables; color: blue
0224y	shortcut cables for 4 channels	for 3 medical safety sockets of 1.5 mm + 1 jumper connector; highly flexible cables; color: yellow
0215	shortcut cables for 8 channels	for 7 medical safety sockets of 1.5 mm + 1 jumper connector; highly flexible cables
0218	shortcut cables for 16 channels	for 15 medical safety sockets of 1.5 mm + 1 jumper connector; highly flexible cables

MOBILE TROLLEY

Product no.	Product name
7020	g.LABboy
Description	
mobile trolley for biosignal recording and data processing devices; with one rack and one drawer; integrated power line with triple socket and power switch; 55x60x115 cm; grey-blue	





Software

RECENT ADVANCES IN
**BRAIN COMPUTER
INTERFACE SYSTEMS**
Edited by Brad R. Postle

INTECH

ELSEVIER

AND
BY



Software overview

g.tec's philosophy is to support all kinds of users with the appropriate software solutions for their projects:

For developers and programmers, there are APIs for Windows/Linux based programming languages as well as for MATLAB. Powerful online/real-time signal acquisition and processing is provided by our High-Speed Online Processing environment for SIMULINK and LabVIEW. Comfortable hardware configuration, signal visualization and storage is possible with g.Recorder, our recording software under Windows. Special plugins for

g.Recorder allow online parameter extraction and visualization for clinical research. Offline biosignal analysis with specialized toolboxes for EEG, ECG, classification, high resolution mapping and CFM analysis is provided with g.BSanalyze (available for MATLAB or stand-alone). For BCI-research systems, we offer ready-to-go examples for various approaches. *intendiX* is the world's first BCI system (P300-speller) developed for patients at home.



g.Recorder

New independent recording software. Visualization and storage of biosignal data in the open hdf5-format. Full access to header information, amplifier setup / configuration and device functionality, full video-EEG. Online visualization, storage and print-out of biosignal parameters HR, HRV and CSA.

Optional: ♦ **g.FEATUREmonitor** Online visualization, classification, storage and print-out of aEEG(CFM) parameters...for clinical research.

g.HIsys – High-speed online processing for SIMULINK

Online biosignal processing and recording with maximum system speed. Easy setup and rapid prototyping for biofeedback/neurofeedback and Brain-Computer Interface applications. No need for Real-Time Windows Target and Compiler, full SIMULINK functionality. Ready-to-go BCI applications available.

Optional: ♦ **g.RTanalyze for SIMULINK** Specialized SIMULINK blockset for real-time/high-speed biosignal analysis and feature extraction (bandpower, Hjorth, Barlow, AAR, filters, heart-rate, heart-rate variability, respiration deepness,...).
♦ **BCI applications** P300 spelling, motor imagery, Common Spatial Patterns, SSVEP robot control, Ping Pong game
♦ **g.EYEtracking Interface** Acquire eye movements together with biosignals
♦ **g.UDPinterface** Send data from Simulink to other computers or receive data
♦ **Noldus Observer Interface** Synchronize data with the Noldus Observer
♦ **g.TRACKINGsystem** Interface to the Noldus EthoVision XT tracking software. Acquire position data together with biosignals.
♦ **g.WiIinterface** Interface to the Nintendo Wii Controller. Acquire position data together with biosignals or use it for controlling the mouse cursor.

g.HIsys – High-speed online processing for LabVIEW

Online biosignal processing and recording with maximum system speed. Easy setup and rapid prototyping for biofeedback/neurofeedback and Brain-Computer Interface applications. Full LabVIEW functionality, easy setup of user-specific applications.

Device drivers for the MATLAB Data Acquisition Toolbox (MATLAB-API)

Full access to the recording buffer and the DAQ device functionality. The Data Acquisition Toolbox enables a quick and easy implementation of data visualization, processing and storage applications under MATLAB. All devices can also be integrated into existing user-specific applications.

API / device driver package

API for user specific applications based on almost any programming language under Windows.

API / device driver package

API for user specific applications based on almost any programming language under Windows or LINUX.

API / device driver package

API for user specific applications based on almost any programming language under Windows or LINUX.

DAQ card / board device drivers

API for user specific applications provided by National Instruments (coming together with the DAQ device).

intendiX

Patient-ready P300 spelling system under Windows, easy operation, for communication and control. World's first personal BCI speller.

Optional: *intendiX* To control external devices, this special extension tool serves as an interface. *intendiX* runs on a separate computer that controls other devices/applications such as TV, music, assistive robots, games and so on. *intendiX* just receives commands from *intendiX*® via UDP and starts/executes the corresponding application or batch.

g.BSanalyze: Offline biosignal processing and analysis

Fully GUI-based software package with specialized toolboxes for EEG analysis, ECG analysis, high resolution EEG, cerebral function, spikes and biosignal data classification. The software supports batch processing and the integration of user-specific MATLAB routines. Powerful result presentation. Stand-alone version available (no MATLAB required).



g.Recorder
BIOSIGNAL RECORDING

Comfortable amplifier configuration, data visualization, storage and review

g.Recorder supports all g.tec biosignal-acquisition devices and provides comfortable configuration and setup of the system. Signals and parameters can be checked in the display mode, stored to disk, and later reviewed in the offline/replay mode.

Video data can be stored simultaneously with the biosignals, and the following parameters can be computed online with g.Recorder:

CSA: Compressed Spectral Array (explorative analysis of signal properties and data quality for long-term recordings)

HR: Heart Rate (based on automatic R-peak detection from the ECG raw signal)

HRV: Heart Rate Variability (HR and HRV parameters reflect the state of the autonomous nervous system)

In the extended version g.Recorder also allows monitoring Cerebral Function/aEEG (amplitude integrated EEG) with automatic pattern classification. This is used to monitor the ongoing brain function of premature infants in the neonatal intensive care unit. This additional plug-in to g.Recorder is called g.FEATUREmonitor. In addition to the online classification, there is also an offline CFM-toolbox available, as a part of g.BSanalyze (g.tec's biosignal analysis software package).

The g.Recorder is also available as complete data acquisition system, including a 16 bit DAQ-card and a coupling box.

PRODUCT HIGHLIGHTS

- ◆ Support for all g.tec biosignal amplifiers
- ◆ Multimodal biosignal visualization and recording
- ◆ Synchronized storage of biosignal data, triggers and video
- ◆ Configuration and setup of hardware parameters
- ◆ Storage of header information and subject/patient data
- ◆ User/Admin mode for save operation
- ◆ Intelligent file management and search functions
- ◆ Stand-alone program



g.FEATUREmonitor, Cerebral Function Monitor for clinical research

SOFTWARE OPTIONS

Product no.	Product name	Description
0167a	g.Recorder for g.USBamp	fully GUI-based (graphical user interface); comfortable biosignal visualization and storage; full control of the amplifier and header; real-time compressed spectral array; heart-rate, heart-rate variability; webcam; single place licence; prerequisite OS English Win 32/64 (Windows 7)
0167b	g.Recorder for g.MOBilab+	fully GUI-based (graphical user interface); comfortable biosignal visualization and storage; full control of the amplifier and header; real-time compressed spectral array; heart-rate, heart-rate variability; webcam; single place licence; prerequisite OS English Win 32/64 (Windows 7)
0167c	g.Recorder for g.BSamp	fully GUI-based (graphical user interface); comfortable biosignal visualization and storage; full control of the amplifier and header; real-time compressed spectral array; heart-rate, heart-rate variability; webcam; single place licence; prerequisite OS English Win 32/64 (Windows 7)
0167d	g.Recorder for g.HIamp	fully GUI-based (graphical user interface); comfortable biosignal visualization and storage; full control of the amplifier and header; real-time compressed spectral array; heart-rate, heart-rate variability; webcam; single place licence; prerequisite OS English Win 32/64 (Windows 7)
0132	g.FEATUREmonitor	multi-channel and multi-modal (cerebral function) biosignal parameter observation software; prerequisite: g.Recorder (0167) ; single place licence

DATA ACQUISITION SYSTEMS / COMPLETE SOLUTIONS

0501	g.Recorder, 16 channels, 16 bit	data acquisition system and software; 16 analog channels; 8 digital I/Os; 16 bit ADC-card; g.16sys (0231); full access to analog and digital signals; SCSI cables; electronic handbook; without PC; including video camera and g.Recorder (0167c); single place licence; prerequisite OS English Win 32/64 (Windows 7)
0505	g.Recorder, 32 channels, 16 bit	data acquisition system and software; 32 analog channels; 8 digital I/Os; 16-bit ADC-card; g.80sys (0235) for 16 analog and 8 digital I/Os; connector box to 16 analog channels; full access to analog and digital signals; SCSI cables; electronic handbook; without PC; including video camera and g.Recorder (0167c); single place licence; prerequisite OS English Win 32/64 (Windows 7)
0509	g.Recorder, 80 channels, 16 bit	data acquisition system and software; 80 analog channels; 8 digital I/Os, 16-bit ADC-card; g.80sys (0235) for 16 analog and 8 digital I/Os; connector box to 64 analog channels; full access to analog and digital signals; SCSI cables; electronic handbook; without PC; including video camera and g.Recorder (0167c); single place licence; prerequisite OS English Win 32/64 (Windows 7)
6061	g.FEATUREmonitor, Neonatal ICU EEG/HRV-monitor, PC included	complete biosignal processing/observation package; consisting of: g.USBamp (16 channel biosignal amplifier, CE-certified, FDA approved, with power supply); g.Recorder + camera and parameter-observation software (CFM, heart-rate, heart-rate variability, compressed spectral array); offline data visualization; fully equipped business PC (with software ready-to-go installation); color printer; trolley for research package; bundle offer (0216+0282+5051+0247+0167a+0287+0132+3001a+3002+7020)
6062	g.FEATUREmonitor, Neonatal research ICU EEG/HRV-monitor, NB included	complete biosignal processing/monitoring package; consisting of: g.USBamp (16 channel biosignal amplifier, CE-certified, FDA approved, with power supply); g.Recorder + camera and parameter-observation software (CFM, heart-rate, heart-rate variability, compressed spectral array); g.Bsanalyze (base version, CFM Toolbox and ECG part I Toolbox) for offline ECG and CFM analysis; fully equipped business notebook (with software ready-to-go installation); color printer; trolley for research package; bundle offer (0216+0282+5051+0247+0167a+0287+0132+0101+0104a+0115+3003+3002+7020); prerequisite MATLAB R2011a for OS English Win 32/64 (Windows 7), Signal Processing Toolbox

University/education prices available



g.Hlsys
LABVIEW HIGH-SPEED
ONLINE PROCESSING

High-speed/real-time data acquisition, processing and analysis under LabVIEW



The High-Speed Online Processing under LabVIEW allows acquiring biosignals like EEG, EMG, EOG, and ECG with LabVIEW.

Therefore the High-Speed Online Processing under LabVIEW block is copied into a LabVIEW project and can be connected to any other available LabVIEW block for further signal processing. The amplifier device driver guarantees that the LabVIEW is updated in real-time.

This Rapid Prototyping environment speeds up the development cycle dramatically, and within a few hours, the first real-time experiments can already be

conducted. The High-Speed Online Processing under LabVIEW allows using all LabVIEW standards and writing your own LabVIEW based programs.

The High-Speed Online Processing under LabVIEW gives access to specific hardware settings like analog channel selection, digital I/O lines, and SD card streaming. Just put the High-Speed Online Processing under LabVIEW in your LabVIEW program and start the biosignal acquisition and analysis.

Biosignal data can be visualized and stored directly to the harddisk in LabVIEW data format.

PRODUCT HIGHLIGHTS

- ◆ Acquire EEG, ECG, EMG, EOG data directly within LabVIEW
- ◆ Wireless biosignal data acquisition with g.MOBILab+ or over USB with g.USBamp
- ◆ Add graphically your own sophisticated data processing algorithms
- ◆ Use standards of LabVIEW for online analysis
- ◆ Benefit from the Rapid Prototyping environment for developing, testing and releasing your biosignal applications
- ◆ No compilation of the LabVIEW is necessary for real-time analysis
- ◆ Store data to a LabVIEW file



EXAMPLES OF LABVIEW VIRTUAL INSTRUMENTS

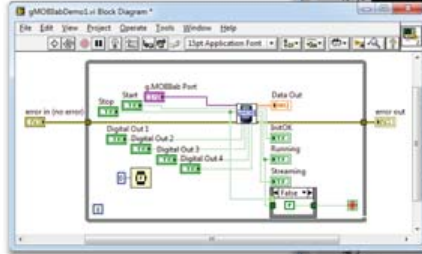

g.MOBilab+ demo block diagram

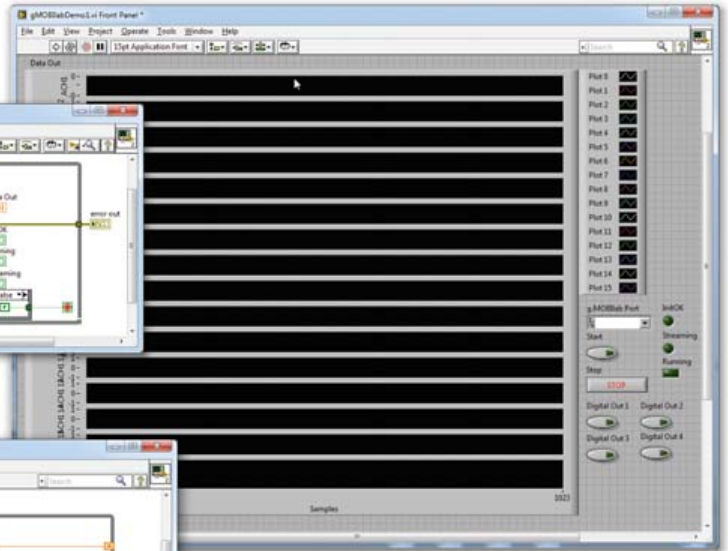

g.MOBilab+ front panel

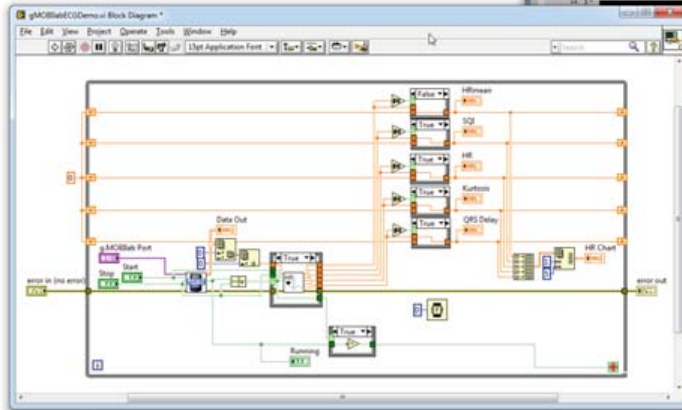

g.MOBilab+ ECG demo

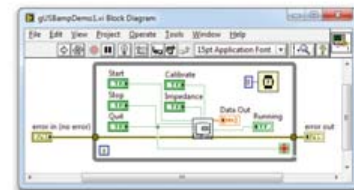

g.USBamp demo

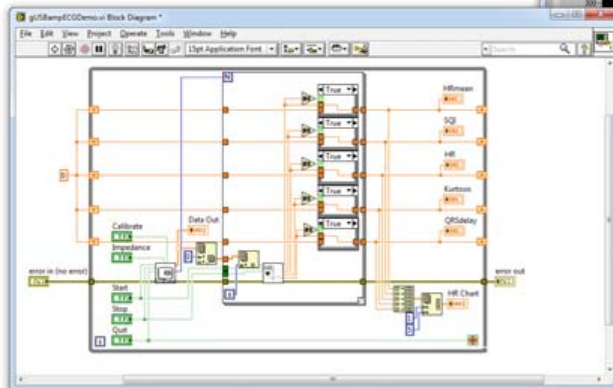

g.USBamp ECG demo block diagram

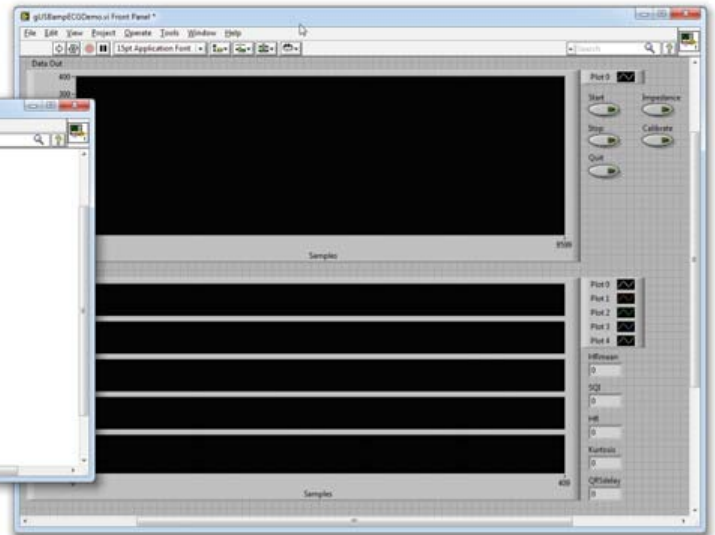

g.USBamp ECG demo front panel

SOFTWARE OPTIONS

Product no.	Product name	Description
0168a	g.USBamp LabVIEW High-Speed Online Processing	LabVIEW drivers and virtual instrument modules; highly optimized hardware-interrupt controlled device driver; allows data processing with the maximum system speed; supports real-time processing of biosignal data, virtual instruments for calibration and impedance check; requires LabVIEW 8.6 or higher; prerequisite OS English Win 32/64 (Windows 7)
0168b	g.MOBilab+ LabVIEW High-Speed Online Processing	LabVIEW drivers and virtual instrument modules; highly optimized hardware-interrupt controlled device driver; allows data processing with the maximum system speed; supports real-time processing of biosignal data, virtual instruments for calibration and impedance check; requires LabVIEW 8.6 or higher; prerequisite OS English Win 32/64 (Windows 7)

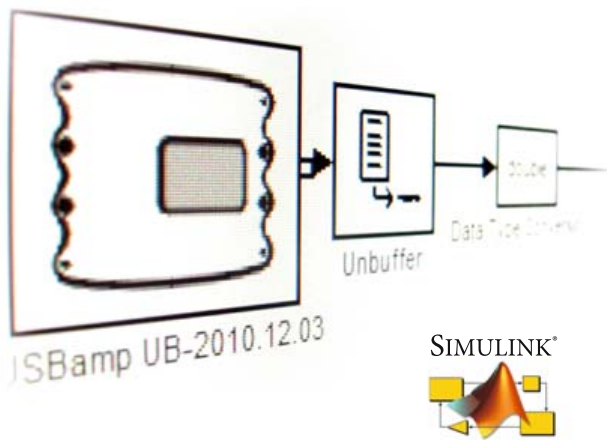

g.Hisys
SIMULINK HIGH-SPEED
ONLINE PROCESSING

High-speed/real-time data acquisition, processing and analysis under SIMULINK

The Highspeed Online Processing blockset is available for g.BSamp, g.MOBllab+, g.HIamp and g.USBamp. The blockset lets you collect biosignal data like EEG, ECoG, EMG, EOG, ECG within a Simulink model for further real-time processing. Therefore, the device driver blocks, g.BSamp, g.MOBllab+, g.HIamp or g.USBamp, are copied into the Simulink model and are connected to other blocks which do the signal analysis. Then, the model is started, and the device driver guarantees real-time processing.

This Rapid Prototyping environment speeds up the development cycle dramatically, and your first real-time experiments are possible within a few hours. The Highspeed Online Processing blockset allows you to use all standard Simulink blocks in your model and to write your own blocks in MATLAB code or C code.

The device driver block gives access to all amplifier specific settings like sampling frequency, digital I/O lines, bandpass and Notch filtering. Just double-click the g.BSamp, the g.MOBllab+, g.HIamp or g.USBamp block to perform the settings. Then, click on Play in the Simulink model to start the biosignal acquisition.

Data can be visualized with Scope blocks and stored to the hard disk in MATLAB format. The model works with double precision accuracy. With g.MOBllab+ it is now possible to store the data during acquisition on an SD card inside the unit.

The g.tec blockset g.RTanalyze supports the Rapid Prototyping of biosignal applications by ready-to-use algorithms. Tutorials are provided for brain-computer interface experiments, ECG analysis and respiration analysis. The Simulink models contained in the Highspeed Online Processing blockset can be used as templates for your own applications.

With the Highspeed Online Processing blockset, we offer the g.EYEtrackingInterface and g.UDPinterface. The packages provide Simulink blocks that can be easily copied into every model to capture also the eye-movements of the subject or to send/receive data to/from other systems. Additionally movements can be captured with the g.WiilInterface and the g.TRACKINGsystem.

PRODUCT HIGHLIGHTS

- ◆ Acquire and process EEG, ECoG, ECG, EMG, EOG, spike data directly within Simulink
- ◆ Add your own sophisticated data processing algorithms graphically
- ◆ Benefit from the Rapid Prototyping environment for developing, testing and releasing your biosignal applications
- ◆ No compilation of the Simulink model is necessary for real-time analysis
- ◆ Wireless biosignal data acquisition with g.MOBllab+
- ◆ Use standard Simulink blocks for online analysis
- ◆ Add your own algorithms as C or MATLAB S-Functions
- ◆ Store data to the MATLAB workspace or to a MATLAB file



EXAMPLES OF SIMULINK DEMO MODELS

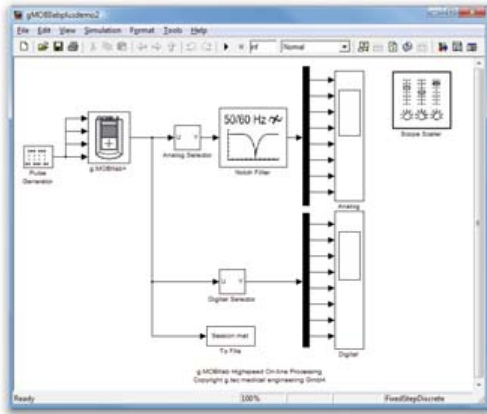

g.MOBilab+ demo model with notch filter and scopes data is saved to a *.mat file

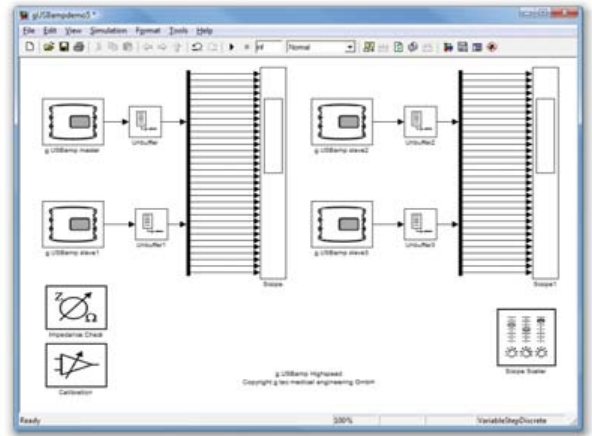

g.USBamp demo model with impedance check and calibration blocks four synchronized amps build a 64-channel system

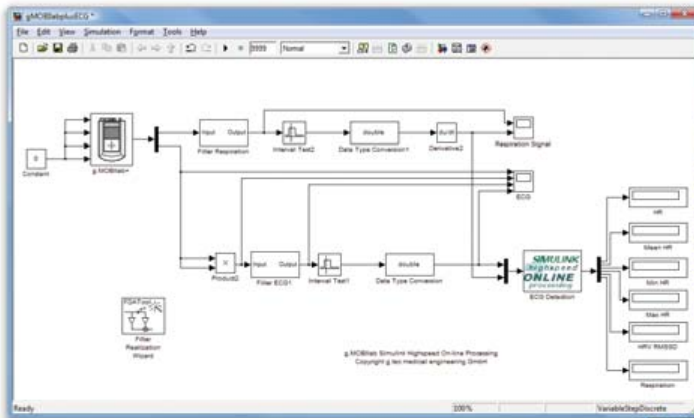

g.MOBilab+ example of real-time HR/HRV and respiration parameter extraction

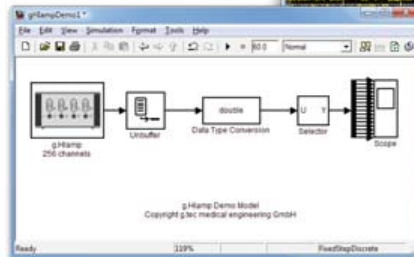

g.Hlamp demo model with scope

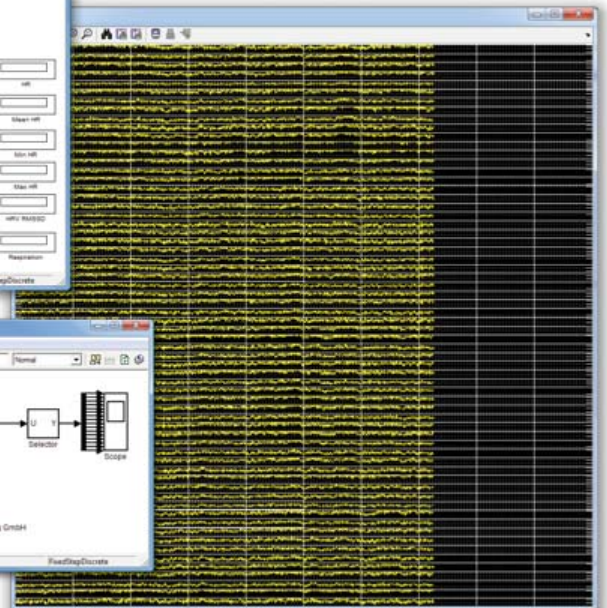

g.Hlamp 64 channel visualization

SOFTWARE OPTIONS

Product no.	Product name	Description
0260d	g.Hlamp SIMULINK HIGH-SPEED ONLINE Processing	SIMULINK driver and blockset modules; highly optimized hardware-interrupt controlled device driver; allowing data processing with the maximum system speed; supports real-time processing of the biosignal data; calibration block; impedance measurement block; signal analysis blocks; single place licence; prerequisite MATLAB R2011a for OS English Win 32/64 (Windows 7), SIMULINK and Signal Processing Blockset
0260a	g.USBamp SIMULINK HIGH-SPEED ONLINE Processing	SIMULINK driver and blockset modules; highly optimized hardware-interrupt controlled device driver; allowing data processing with the maximum system speed; supports real-time processing of the biosignal data; calibration block; impedance measurement block; signal analysis blocks; single place licence; prerequisite MATLAB R2011a for OS English Win 32/64 (Windows 7), SIMULINK and Signal Processing Blockset
0260c	g.BSamp SIMULINK HIGH-SPEED ONLINE Processing	SIMULINK driver and blockset modules; highly optimized hardware-interrupt controlled device driver; allowing data processing with the maximum system speed; supports real-time processing of the biosignal data; signal analysis blocks; single place licence; prerequisite MATLAB R2011a for OS English Win 32/64 (Windows 7), SIMULINK and Signal Processing Blockset
5012a	g.MOBilab+ SIMULINK HIGH-SPEED ONLINE Processing	SIMULINK driver and blockset modules; highly optimized hardware-interrupt controlled device driver; allowing data processing with the maximum system speed; supports real-time processing of the biosignal data; signal analysis blocks; single place licence; prerequisite MATLAB R2011a for OS English Win 32/64 (Windows 7), SIMULINK



Online and real-time biosignal processing library for use with SIMULINK

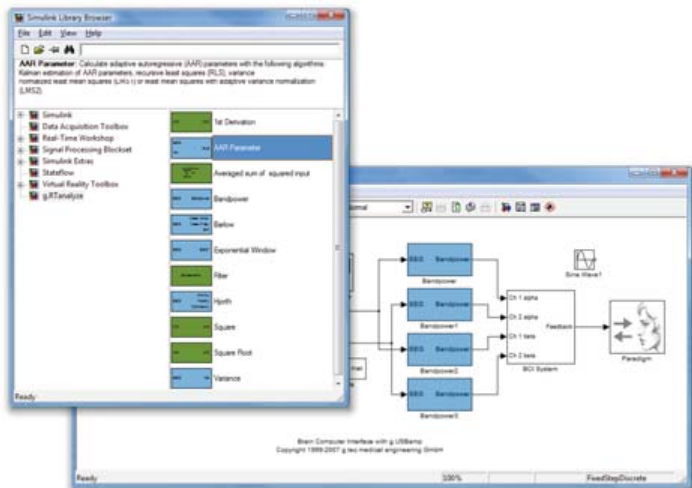

g.RTanalyze is a biosignal processing blockset for use with Simulink (MathWorks Inc., Natick, USA). The g.RTanalyze blocks can be used for on-line simulations under Simulink and for real-time applications with Highspeed Online Processing for SIMULINK.

Drag and drop the pre-processing, parameter estimation and classification algorithms to your SIMULINK real-time application to accelerate your research, encourage creativity and reduce project costs. The blockset enables you to quickly compare multiple algorithms. Use the blocks as template and make your own modifications.

The blockset is divided into general purpose blocks and biosignal processing blocks. General purpose blocks are derivations, filters and different algebraic blocks. Biosignal processing blocks are used for pre-processing, parameter estimation and classification of off-line or real-time EEG, ECG, respiration or galvanic skin response data.

Included parameter estimation blocks are: Hjorth parameters, Barlow parameters, Bandpower, Variance and Adaptive Autoregressive Models with RLS, Kalman and LMS algorithms and minimum energy. All methods are standard in BCI research for P300, motor imagery, SSVEP/SSSEP and slow cortical potential based systems. The ECG block allows to calculate heart-rate and heart-rate variability parameters. Furthermore respiration rate/depth and the change rate of galvanic skin response can be calculated.

The apply classifier block allows to use linear and non-linear classifiers for the on-line classification of parameters. Examples are linear discriminant analysis or support vector machine based classifiers calculated in g.BSanalyze. Furthermore blocks for majority voting and change rate calculation are included.

PRODUCT HIGHLIGHTS

- ◆ Optimized pre-processing, signal processing, feature extraction and classification blocks
- ◆ Helps to design your real-time application rapidly
- ◆ Code can be used for off-line and on-line biosignal analysis
- ◆ Algorithms for fast, accurate, flexible simulations and estimations
- ◆ Blocks for EEG, ECG, respiration and GSR analysis
- ◆ On-line classification with LDA, SVM,... included

SOFTWARE OPTIONS

Product no.	Product name	Description
0111	g.RTanalyze	real-time EEG, ECG, respiration, galvanic skin response and biosignal processing blockset under SIMULINK; real-time algorithms; single place license; prerequisite MATLAB R2011a for OS English Win 32/64 (Windows 7), SIMULINK

University/education prices available



g.BSanalyze

BIOSIGNAL ANALYSIS



CinC Challenge 2006

COMPUTING IN CARDIOLOGY

Offline biosignal analysis with powerful toolboxes

g.BSanalyze is an interactive environment for multimodal biosignal data processing and analysis in the fields of clinical research and life sciences that is now for 10 years on the market and is used in more than 60 countries. It is the most comprehensive package to analyze non-invasive and invasive brain-, heart- and muscle-functions and dysfunctions.

The package won several international Awards. Version 4.11 includes many new functions such as support vector machines, event-related ECG, support for P300 and SSVEP/SSSEP BCIs, compressed spectral array, minimum energy, ...

The combination of the graphical user interface and the programming environment makes g.BSanalyze a truly unique package for biosignal analyses.

The package comes with many example biosignal data-sets such as P300, SSVEP, motor imagery, CSP BCIs, Tilt-Table, EPs, multi-unit activity, CFM, ERD/ERS, ...

g.BSanalyze's graphical user interface includes more than 100 state-of-the-art functions for defining electrode montages, spatial or temporal filter designs, artifact treatment, quality control, spectral analysis, coherence, correlation, bandpower analysis, ERD/ERS analyses, EP analyses, visualization, data set classification, ...

It is the only package that supports all BCI principles: P300, SSVEP/SSSEP, motor imagery and slow cortical potentials. You can load and save your preferred processing steps as a script program and automatically process your data in g.BSanalyze batch mode.

g.BSanalyze's processing capabilities allow you to extract relevant features of your multimodal data and to define useful parameters for postprocessing. Use these parameters directly with g.BSanalyze's classification tools to assign distinct classes to your data with linear and non-linear classifiers.

The stand-alone version of g.BSanalyze can run without a Matlab installation.

PRODUCT HIGHLIGHTS

- ◆ interactive and intuitive graphical user interface for EEG, ECoG, EOG, EMG, ECG, spike... and physical data analyses and documentation under MATLAB as well as a stand-alone version
- ◆ analyze data from: g.Recorder, Highspeed On-line Processing for SIMULINK, MATLAB and C API and many other 3rd-party recording devices
- ◆ extensive tools for data processing in time, space, and frequency domains
- ◆ powerful 2-D and 3-D visualization tools to rapidly generate publication ready figures
- ◆ enhancement of power with g.tec's specialized EEG, aEEG, ECG, SPIKE, CLASSIFY and High-Resolution EEG toolboxes
- ◆ flexibility to integrate other MATLAB toolboxes, as well as customers' specific algorithms
- ◆ more than 100 state-of-the-art functions for analyzing biosignal data
- ◆ 10 years of development and used in more than 60 countries worldwide
- ◆ the only package that supports all BCI principles: P300, motor imagery, SSVEP/SSSEP, slow cortical potentials



Data visualization

Data ruler, Undo (1-step, multi-step), Journal file, Full header access, High speed data scrolling (trial x channel/channel x trial), Assign and edit data attributes and markers, Epoching (free/multi trial/multi channel mode), Data scoring, Quick analyses of epochs, Assign comments, Attribute jumper, Data status monitor, Data player, Zoom, Data scaling (auto, amplifier, manual, type specific)

Data file I/O and Printing

Import filter: MATLAB, EDF, BKR, ASCII, RDF, CNT, TFM, MOBILAB, AXONA, BIOPAC, MICROMED, MIT, BIOSEMI, Block import, Full support for 3rd-party formats, Export ASCII, Assign class labels, Plot data, Printer options

Transformation

Cut trials-samples-channels, Sort data, Merge data sets, Arithmetic operations, Data triggering (on multiple triggers), Untrigger data

Pre-processing

DC-correction, Smoothing/Rectifying, Data detrending, Remove drift, Down- and upsampling, Filter data (highpass, lowpass, bandpass, bandstop), Filter design with graphic support, Spatial filtering, Moving average, Baseline correction

Tools

Stimulus/response detector, Reaction time analysis, Single trial analysis, Trigger finder

Artifact treatment

Overflows, Zerolines, Eventfinder with automatic attribute/marker assignment, Artifact removal with ICA/spatial filters

Analyze

Independent Component Analysis (ICA), Principal Component Analysis (PCA)

Batch mode

Automatic generation of journal files, Batch mode processing for multiple data sets

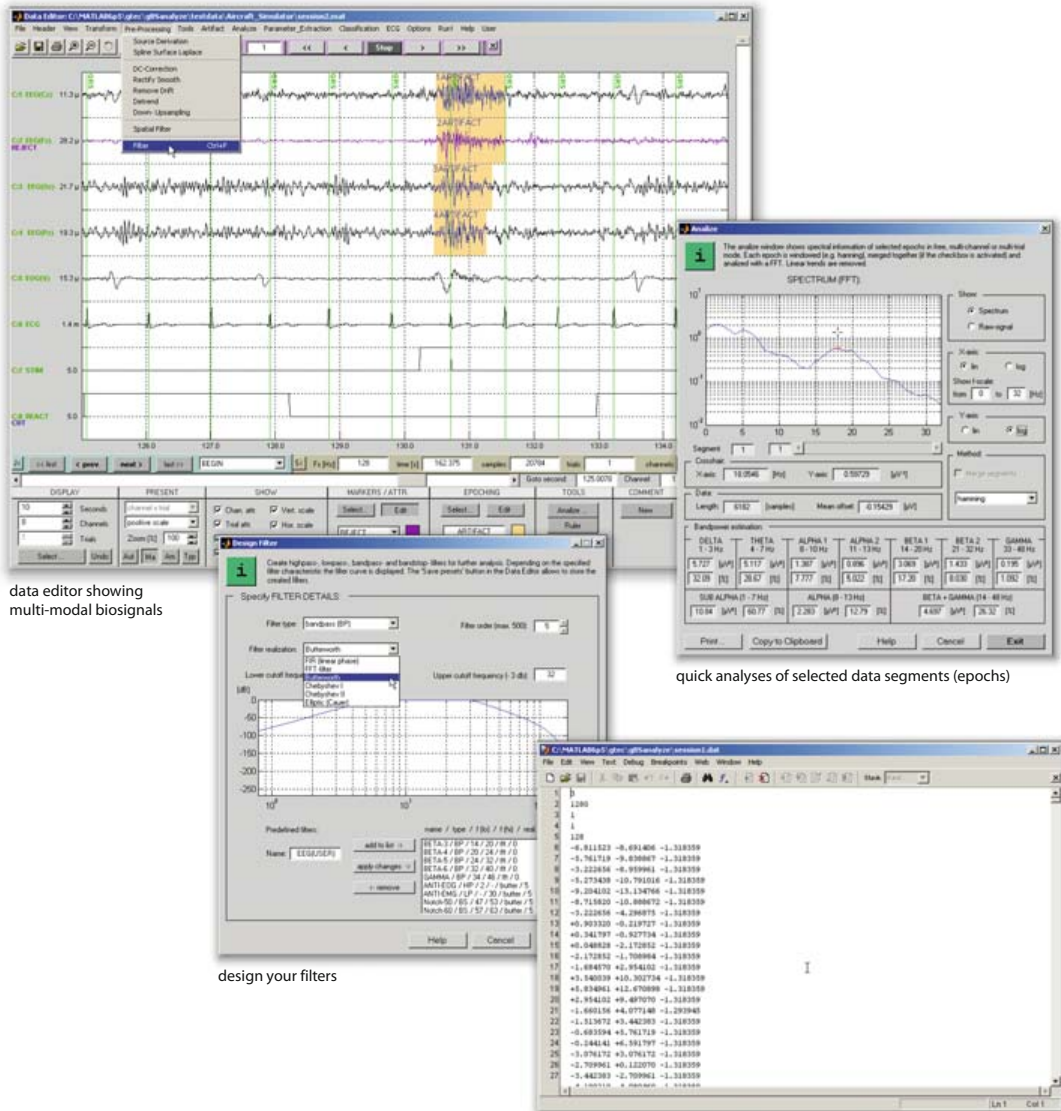

data editor showing multi-modal biosignals

quick analyses of selected data segments (epochs)

design your filters

easy import and export of almost any data formats



GENERAL ANALYSIS: SIGNAL ANALYSES, PARAMETER EXTRACTION, 2D-RESULTS, ... (INCLUDED IN EEG AND ECG TOOLBOX)

Analyze functions

Data quality (histogram, distribution and statistic measures), Average across trials (EP analysis, baseline correction, SNR, graph comparison, ...), Power spectrum analysis and significance test of differences, Wavelet analysis

Parameter extraction

Adaptive autoregressive (AAR) parameters Signal variance, Bandpower, Exponential window, Cross correlation and CC-based template matching, Minimum energy

Result visualization

2D plots of analysis results, Layout editor, Copy and measure, Background image, ASCII export, Clone plots, Topography, Header editor

Pre-processing

Source derivation

Montage creator

Edit topography/electrode positions according to the international 10-20 system or free electrode system, Specify source derivations (BIP/CAR/LAR/LAP,...), Edit geometry data

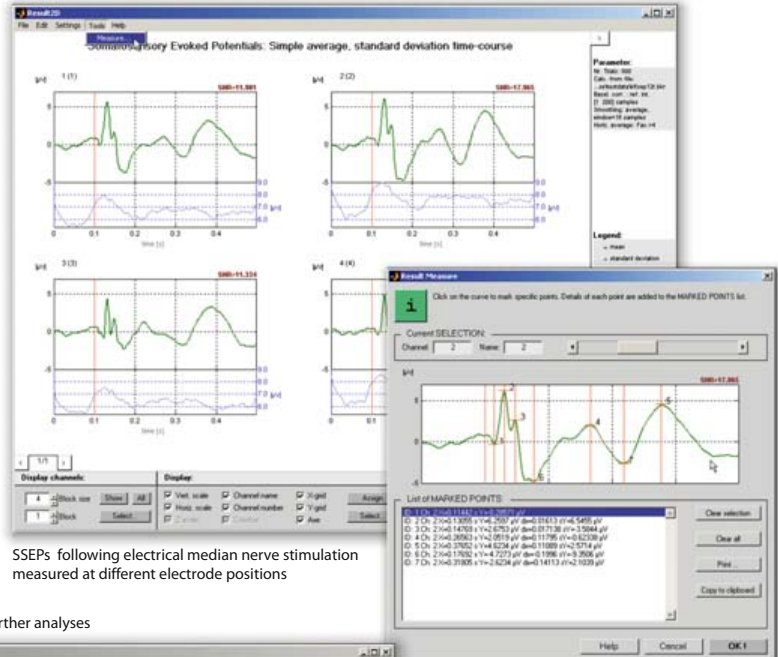

SSEPs following electrical median nerve stimulation measured at different electrode positions

extract different parameters from biosignal raw data for further analyses

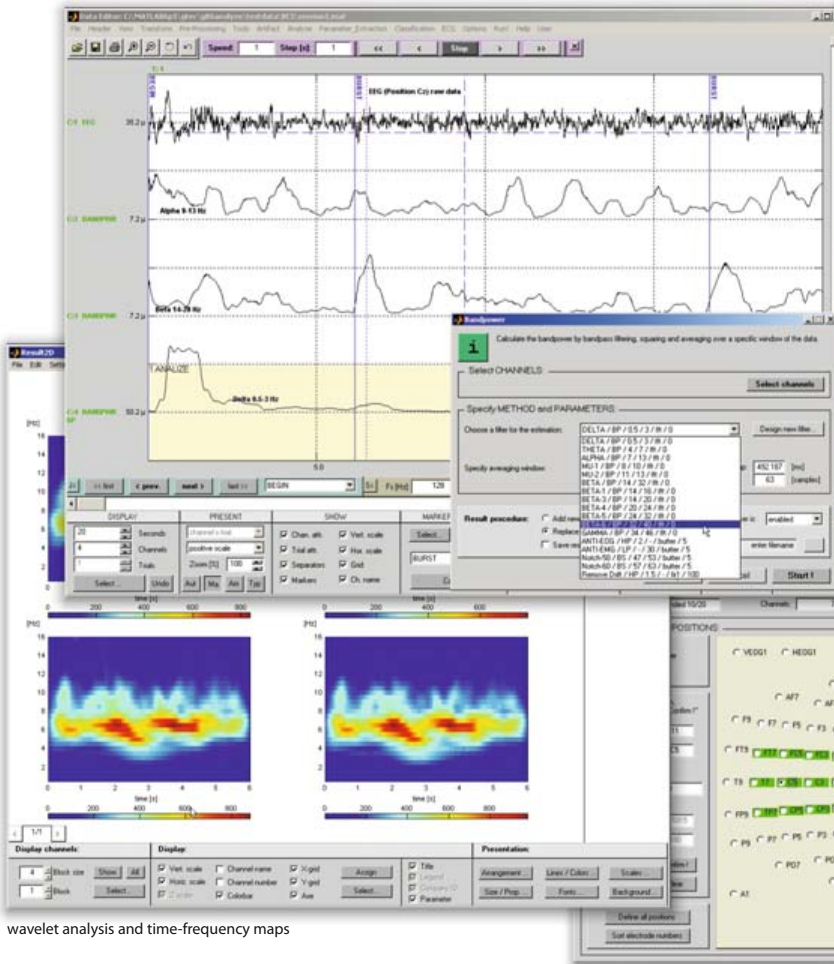

wavelet analysis and time-frequency maps

measure characteristic points in the result plots

result plots for recordings with up to 128 channels

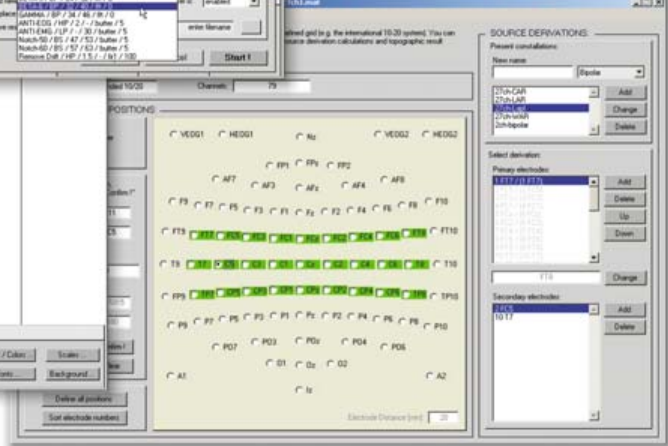
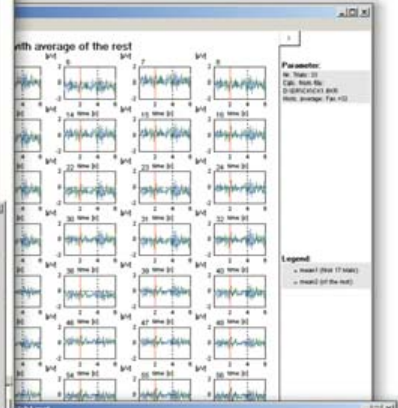

define electrode positions and configurations for source derivations

ECG specific analyze functions

Coherence, Event-related coherence, Event-related ECG changes

QRS/R-peak detector

QRS complex detector with deviant complex detector, Automatic detection, classification and counting of normal beats, atrial/ventricular extrasystoles, bundle branch block, artifacts, ...

Parameter extraction

Tachogram

HR/HRV (heart rate/heart rate variability)

HR/HRV time domain parameters, Geometric measures, RR difference measures, Segmented measures, Poincaré plots, HR/HRV frequency domain parameters, Power measures, Normalized measures, HRV time-frequency maps

ECG single beat analysis

Single beat editor, Automatic beat-by-beat detection of characteristic points:

Pon, P, Poff, QRson, Q, R, S, QRsoff, Ton, T, Toff, Extraction of corresponding intervals, durations, amplitudes/levels and other parameters, Time evolution plots for parameters, QT-interval and ST-segment analysis for identification of pathological changes, Recording reports

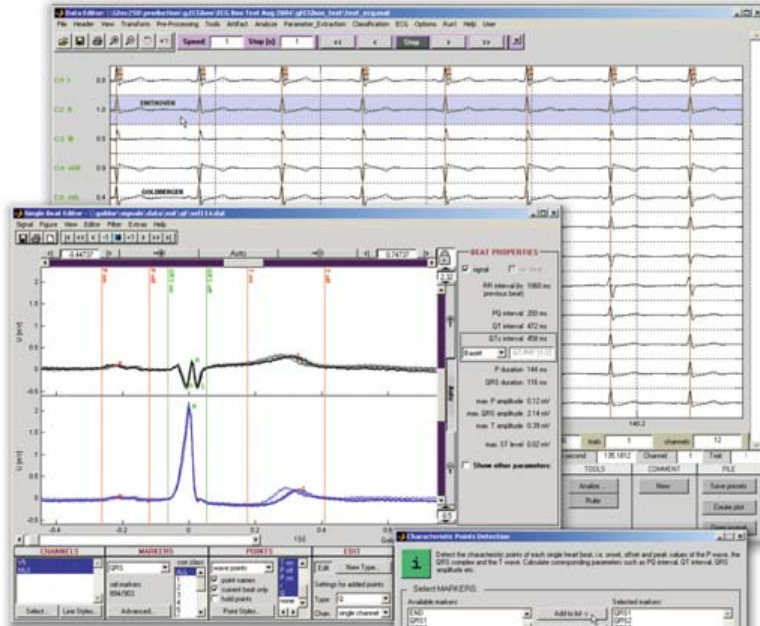

single beat editor showing characteristic points

time courses and histograms of specific parameters

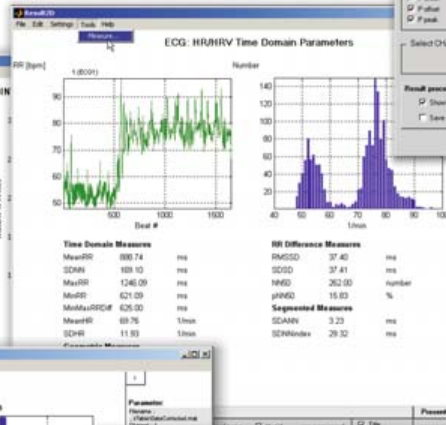
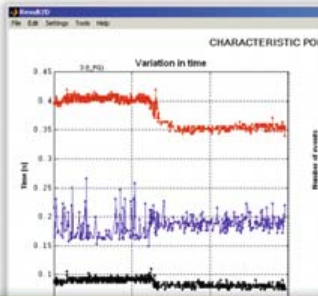

select markers and characteristic points

HR/HRV (heart rate, heart rate variability) parameters in the time domain

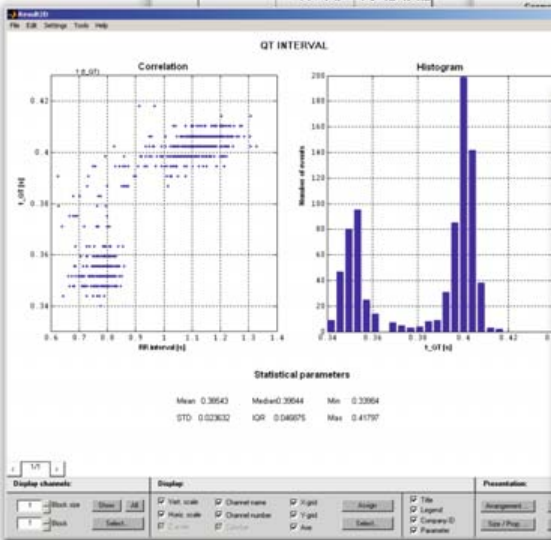

QT interval analysis

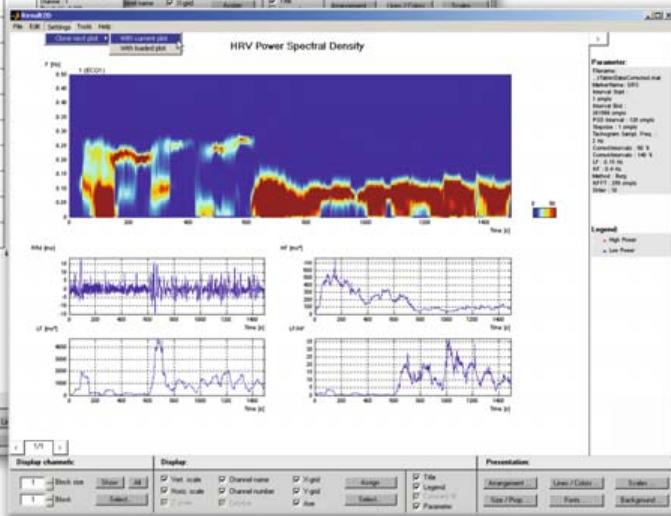

HRV: time-frequency maps



EEG TOOLBOX: SPECIALIZED ANALYSES FOR THE ELECTROENCEPHALOGRAM

easy handling, viewing, scoring, transformation and processing of multi-channel EEG recordings

EEG specific analyze functions

Coherence, Event-related coherence, ERD/ERS analysis with significance test, ERD/ERS time-frequency maps with bootstrap test for significance, ERD/ERS time-frequency maps with complex demodulation, ERD/ERS time-frequency maps with wavelets, ERD/ERS time-frequency maps with Hilbert transformation, Common spatial patterns (CSP), Mean frequency, Phaselocking value

Parameter extraction

Hjorth parameters, Barlow parameters, Running fractal dimension, Temporal and spatial complexity, P300 accuracy

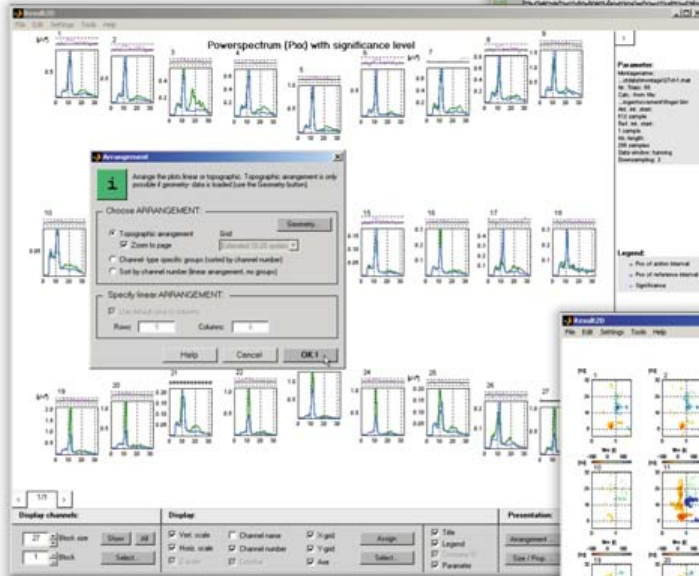
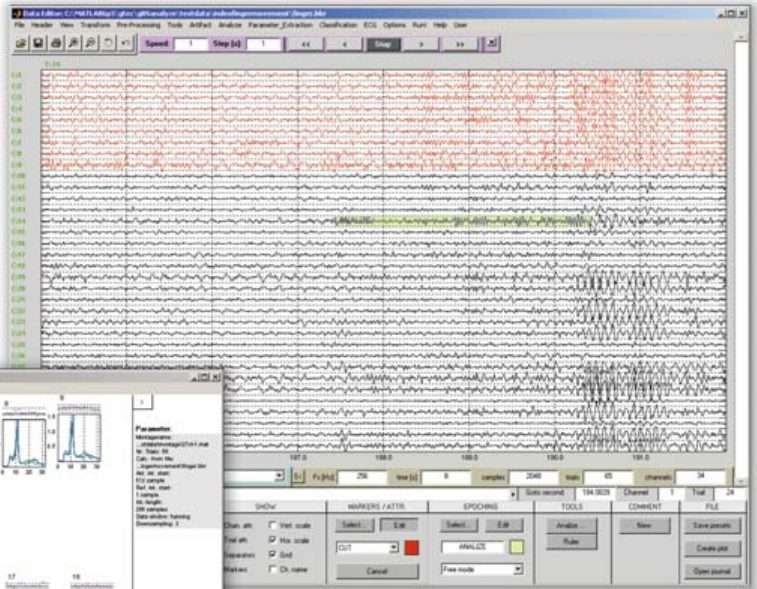

ERD/ERS time-frequency maps: a comprehensive overview of the dynamic of oscillatory EEG components (with bootstrap test)

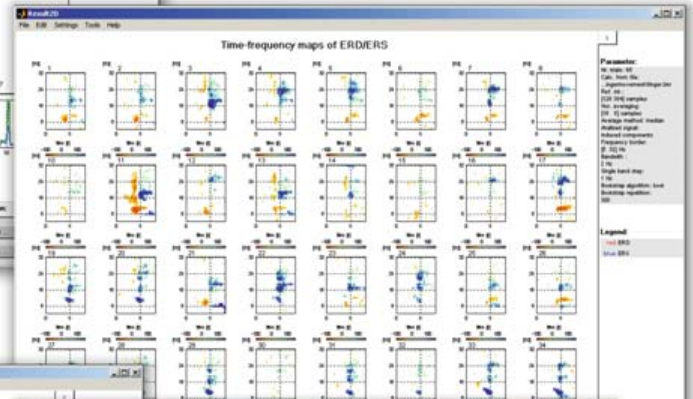

topographic arrangement of multi-channel results: spectral comparison with significance test

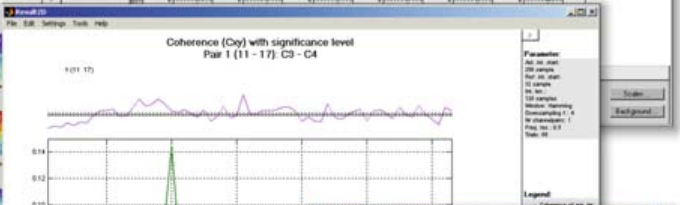
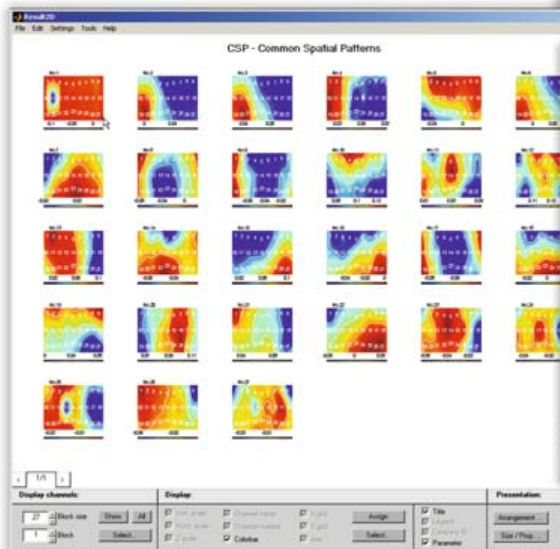

coherence analysis for predefined pairs of channels (and comparison with significance test)



common spatial patterns allow generating new time series for optimal distinction between classes (maps display CSPs with topographic information arranged according from the most distinctive to the least one)



CLASSIFY TOOLBOX: BIOSIGNAL CLASSIFICATION METHODS

Tools

Generate feature matrix, Generate time segment feature matrix, Test classifier, Apply classifier, Store classifiers for online application (biofeedback, BCI, ...)

Methods

Multi-class linear discriminant analysis, Minimum distance classifier, Backpropagation neural network, Receiver operator curves, Radial basis function, Distinction sensitive learning vectorquantization (DSLQV), DSLVQ for feature weighting, K-means clustering, Support vector machine, Change rate/majority voting

step by step: generate multi-class feature matrices

discriminate between specific time segments within trials

compute classifiers with various methods and evaluate them with validation tests

apply a classifier computed from training data to new test data sets

the validation of a classifier leads to a classification error (e.g. as a function of time)

The collage illustrates the classification process. It starts with 'Generate Feature Matrix' and 'Generate time segment feature matrix' windows. The 'Linear Classifier' window shows parameters like 'Name of feature matrix file' and 'Dimension'. The 'Apply Classifier' window shows 'Load classifier from file' and 'Method'. The 'Linear Discriminant Analysis: Classification Error' window shows a line graph of error percentage over time. The 'ROC Curve and HF difference' window shows an ROC curve with 'Area: 0.79 Threshold: 581.56'. The 'Distribution' window shows a histogram of feature values. The 'Feature Weighting' window shows bar charts for 'Feature 1' through 'Feature 4'. The 'KMEANS clustering' window shows scatter plots of feature vectors.

classifier reports and weight vectors are stored for further applications

DSLQV feature weighting helps to identify the most important features for a discrimination task

ROC curves can be used for threshold optimization to achieve the maximum discrimination between hits and false

KMEANS clustering finds the optimal position of codebook vectors in k-means



HIGH RESOLUTION EEG TOOLBOX: REALISTIC ANATOMICAL MULTI-LAYER MODELS AND RESULT MAPPING

Pre-processing

High resolution spline Laplacian derivations for ERD/ERS, ERP, ...

Anatomical modeling

Generation of realistic anatomical multi-layer models from segmented CT/MRI data, Fit electrode positions to models, Edit geometry data

Result mapping

2D and 3D mapping of results for different model layers, Edit transparency and colors, Free rotation of models/maps, Generate time series

different model layers and combinations: scalp, brain, electrodes, data on scalp, interpolation of data on brain surface

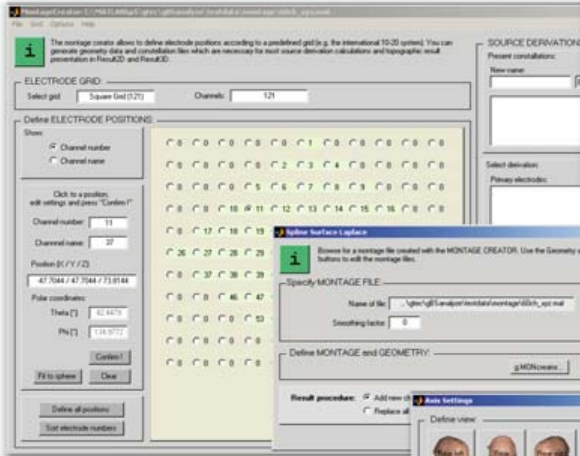

define (or import) electrode positions for spline surface Laplacian derivations

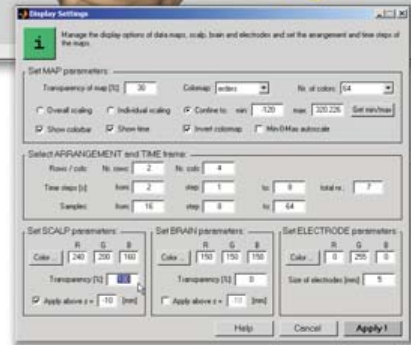
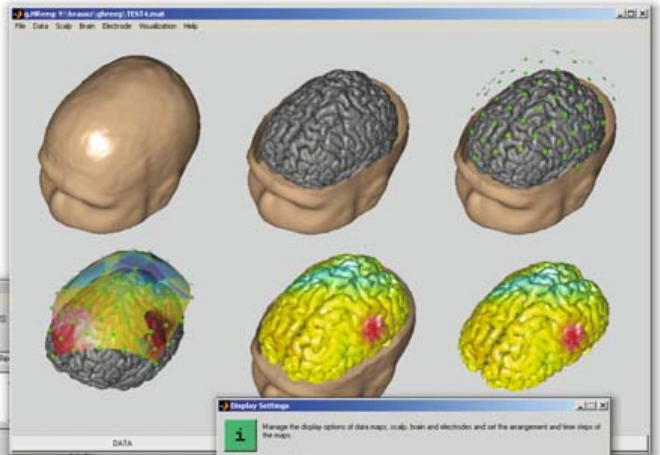

specify colors, parameters and transparency for the different layers

define the view or use the free rotation tool

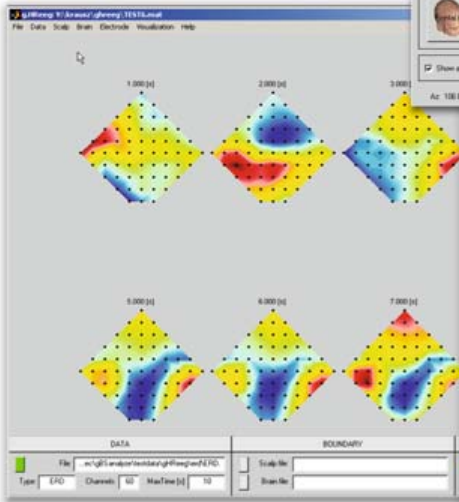

2D-map time series with electrode positions

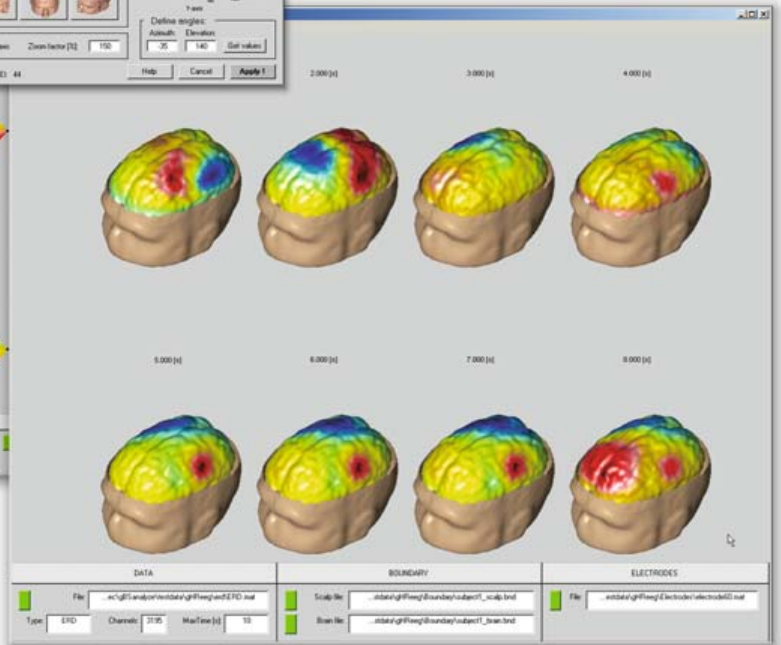

high resolution mapping of an ERD/ERS time series with realistic head (and brain) model generated from segmented MRIs



Offline analysis of neonate EEG

The CFM (aEEG) signal can be computed from selected data segments. The CFM traces are displayed in a viewer window for visual inspection.

Automatic CFM segmentation

CFM traces can be classified automatically. The following classes are assigned to data segments of a predefined length (e.g. 10 min):

- CVP ... continous voltage pattern
- DLVP ... discont. low voltage pattern
- DHVP ... discont. high voltage pattern
- ISO ... isoelectric pattern
- BSP ... burst suppression mode
- BURST ... bursts

Criteria for automatic segmentation can be adjusted/optimized for special applications or derivation techniques.

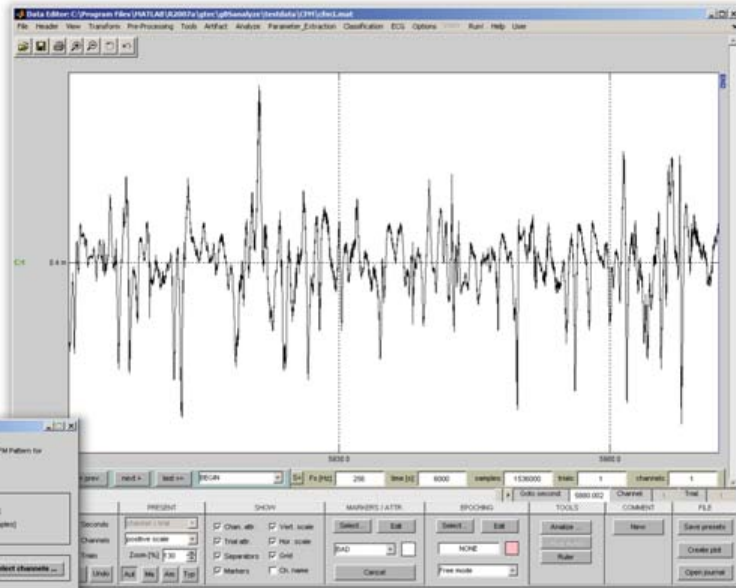

raw data visualization and preprocessing in the Data Editor



Interval and parameter selection for CFM calculation

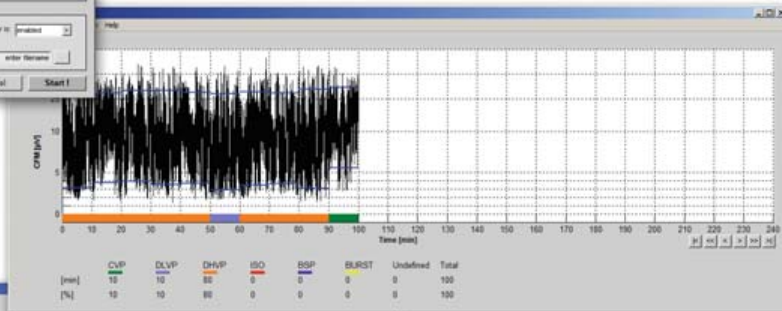

CFM traces and classification results are displayed in the CFM viewer



setup for automatic CFM segmentation: criteria for each class can be modified separately



SPIKE TOOLBOX

Neuronal activity processing

PSTH – Peristimulus Time Histogram

Analyze position data

Map physiological parameters onto position data

Analyze place cells and place fields

Calculate different map parameters

Max. activity, Mean activity, Spatial coherence, Spatial selectivity, Mean non-zero rate, Skaggs index

Calculate speed

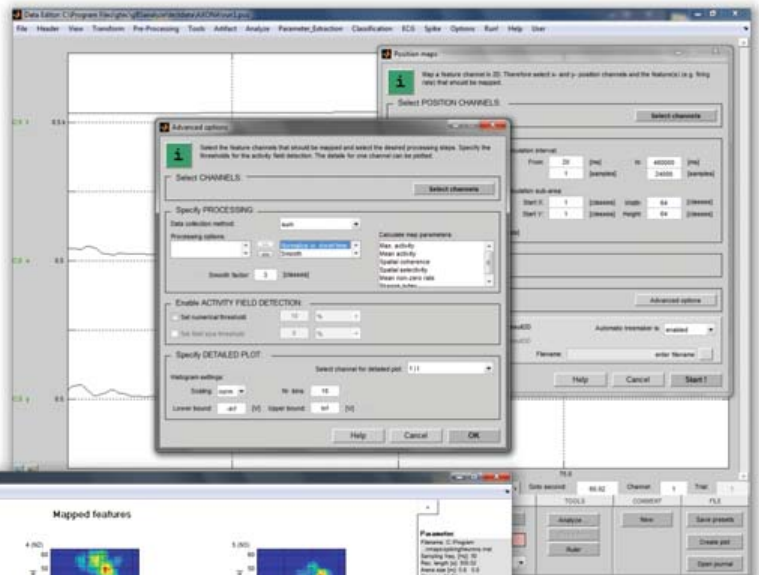

position map parameter specification and advanced options

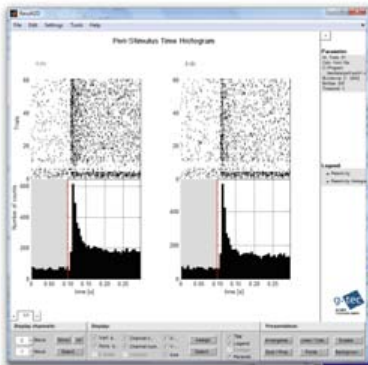

Peri-Stimulus Time Histogram

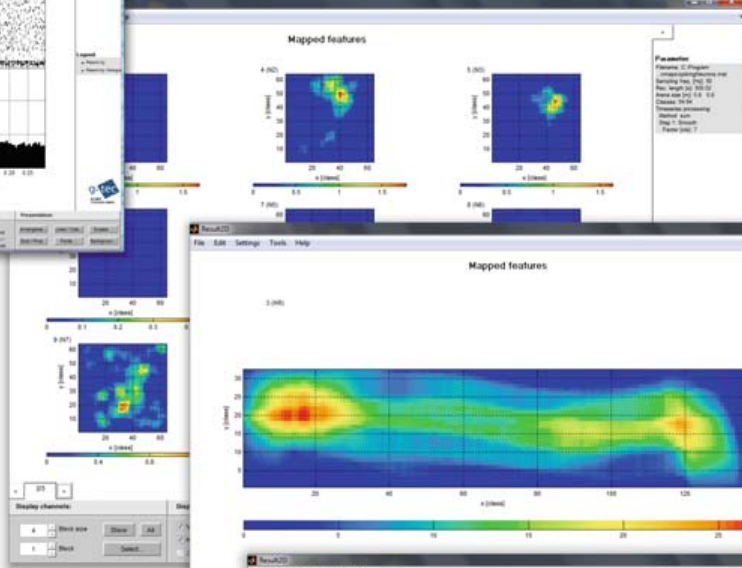

firing maps of different neurons

mapped features

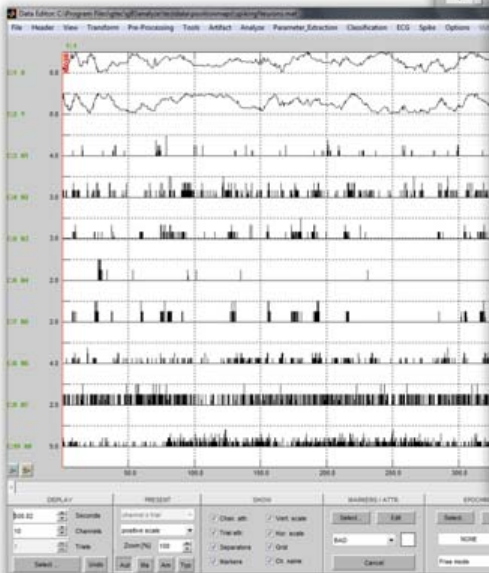
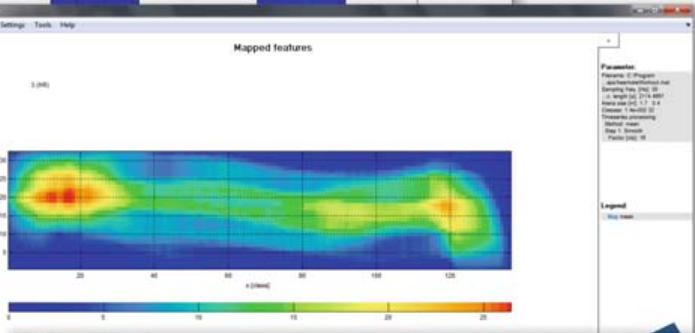

position data and spike activity



histogram and identified fields

**BSANALYZE TOOLBOXES**

Product no.	Product name	Description
0101	g.BSanalyze: Base Version	advanced biosignal data processing toolbox, basic version, needed for using further g.BSanalyze toolboxes; prerequisite MATLAB R2011a for OS English Win 32/64 (Windows 7), Signal Processing Toolbox
0102	g.BSanalyze: EEG-toolbox	specialised EEG processing toolbox: includes specialised functions for EEG data analysis, parameter extraction, result presentation according to an editable electrode arrangement, source derivation calculation and various methods for spectral analysis and comparison; prerequisite MATLAB R2011a for OS English Win 32/64 (Windows 7), Signal Processing Toolbox
0104a	g.BSanalyze: ECG-toolbox part I	specialised ECG processing toolbox (according to the US/European task force) for HR (heart rate) and HRV (heart rate variability) analysis in time and frequency domain; prerequisite MATLAB R2011a for OS English Win 32/64 (Windows 7), Signal Processing Toolbox
0104b	g.BSanalyze: ECG-toolbox part II	specialised ECG processing toolbox for single beat classification and analysis; prerequisite MATLAB R2011a for OS English Win 32/64 (Windows 7), Signal Processing Toolbox
0105	g.BSanalyze: Classify toolbox	specialised data classification toolbox, which enables to categorize patterns and signal features of biosignals into different classes; prerequisite MATLAB R2011a for OS English Win 32/64 (Windows 7), Signal Processing Toolbox
0110	g.BSanalyze: High-Resolution Toolbox	high resolution 3D-spline Laplacian and mapping software; allows to combine EEG analysis with the anatomy of the brain (MRI/fMRI/CT data). It includes head model generation from MR/CT segmented volumes; prerequisite MATLAB R2011a for OS English Win 32/64
0115	g.BSanalyze: CFM toolbox	amplitude integrated EEG calculation with automatic segmentation; prerequisite MATLAB R2011a for OS English Win 32/64 (Windows 7), Signal Processing Toolbox
0116	g.BSanalyze: SPIKE toolbox	specialised spike processing toolbox: includes specialised functions for spike and position data analysis, spike rate, firing field, dwell time, statistical parameters; prerequisite MATLAB R2011a for OS English Win 32/64 (Windows 7), Signal Processing Toolbox
Stand-alone version for use without MATLAB available		
University/education prices available		

BSANALYZE BUNDLE OFFERS

Product no.	Product name	Description
0151	bundle (g.BSanalyze: EEG+ECG I+II)	g.BSanalyze Base Version + g.BSanalyze EEG-toolbox + g.BSanalyze ECG-toolbox part I + part II; bundle offer (0101+0102+0104a+b)
0152	bundle (g.BSanalyze: EEG+ECG I)	g.BSanalyze Base Version + g.BSanalyze EEG-toolbox + g.BSanalyze ECG-toolbox part I; bundle offer (0101+0102+0104a)
0153	bundle (g.BSanalyze: EEG+Classify)	brain computer interface analysis – g.BSanalyze Base Version + g.BSanalyze EEG-toolbox + g.BSanalyze Classify toolbox; bundle offer (0101+0102+0105)
Stand-alone version for use without MATLAB available		
University/education prices available		

SUBSCRIPTION AND SUPPORT**Subscription**

g.BSanalyze comes with a hardlock for an unlimited single-place license or classroom license. The software includes a 1-year subscription with free updates. The subscription can be renewed after 1 year.

Support

On-demand implementation of user specific methods/algorithms. Full e-mail/phone support with minimum delay. Full support for 3rd party data formats.

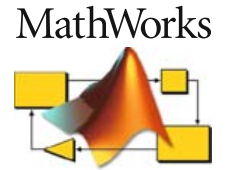

API for MATLAB – g.tec’s device driver for the MATLAB Data Acquisition Toolbox

The API for MATLAB is available for g.USBamp and the g.MOBilab+. The toolbox is a device driver that lets users read biosignal data like EEG, ECoG, EMG, EOG and ECG within the MATLAB environment. MATLAB is a very flexible development environment which allows you to easily set up your own signal acquisition and analysis by utilizing all available toolboxes from MATLAB (like Statistics, Neural Networks, and Signal Processing).

The API for MATLAB contains commands which give full access to the amplifier. There are commands for reading the data, setting the bandpass and Notch filters, changing the sampling frequency of the amplifier, defining bipolar derivations and calibrating the system.

Multiple g.USBamps can be used if they are connected with a synchronization cable to work in absolute synchrony. In this situation, one device must be defined as master to control the other amplifiers.

An integrated impedance check gives you the impedance values of passive electrodes connected to the 16 input channels and 4 reference channels.

One of the key advantages of API for MATLAB is that it is fully integrated into the MATLAB Data Acquisition Toolbox. Therefore, you can start data acquisition within minutes, and build your application easily and quickly on top of it.

PRODUCT HIGHLIGHTS

- ◆ Acquire EEG, ECoG, ECG, EMG, EOG data directly within MATLAB
- ◆ Control g.USBamp and g.MOBilab+ from the MATLAB command line
- ◆ Write your own MATLAB programs for on-line visualization and signal analysis
- ◆ Easily use the MATLAB Data Acquisition Toolbox to handle g.USBamp
- ◆ Data can be read directly into MATLAB for further off-line processing
- ◆ Speed up your development time from months to hours

SOFTWARE OPTIONS

Product no.	Product name	Description
0261	g.USBamp API for MATLAB	MATLAB programming driver package for g.USBamp; single place licence; prerequisite MATLAB R2011a for OS English Win 32 (Windows 7), Data Acquisition Toolbox
5016	g.MOBilab+ API for MATLAB	MATLAB driver software package for g.MOBilab+; full access to the amplifier from MATLAB command window; for user specific applications under MATLAB; single place licence; prerequisite MATLAB R2011a for OS English Win 32 (Windows 7), Data Acquisition Toolbox



C API – g.tec’s Application Programming Interface for Windows and Linux

The Application Programming Interface (API) allows you to access the amplifier from many programming environments. The API has functions to fully control the amplifier from C, C++, Visual Basic, LabWindows and many more programming languages. The API is available for Windows and Linux operating systems. It enables you to program your own sophisticated biosignal acquisition and data processing applications. Sample programs and the well documented source code in the electronic manual serve as a template for your programs. The device driver package contains demo programs that show you the usage of all functions and help to get started with the API.

The device driver for g.USBamp and g.HIamp gives access to the data which is sent over USB to the computer. Bandpass and Notch filter settings can be performed, the sampling frequency can be selected, a test signal can be applied and the amplifier can be calibrated by your own program. Bipolar derivations can be calculated between two electrodes.

The g.MOBllab+ API allows you to set up the communication with the g.MOBllab+ amplifier, to initialize the amplifier, to start and stop the data acquisition, to set and reset digital I/O lines and to store data on the device.

PRODUCT HIGHLIGHTS

- ◆ Acquire EEG, ECoG, ECG, EMG, EOG data in your own programs
- ◆ Available for Windows and Linux
- ◆ Include your own sophisticated data processing algorithms
- ◆ Develop stand-alone programs for biosignal analysis

SOFTWARE OPTIONS

Product no.	Product name	Description
7263	g.HIamp C API	application programming interface (API) for user specific application (eg. developed in C/C++); single place licence; prerequisite OS English Win 32/64 (Windows 7)
0263	g.USBamp C API	application programming interface (API) for user specific application (eg. developed in C/C++); single place licence; prerequisite OS English Win 32/64 (Windows 7)
0169a	Linux API for g.USBamp	driver software package for g.USBamp; full access to recording buffer; for user specific applications on the PC; single place licence; prerequisite Ubuntu Linux 10.x, 32bit
5011	g.MOBllab+ C API	driver software package for g.MOBllab+; full access to recording buffer; for user specific applications on the PC; single place licence; prerequisite OS English Win 32/64 (Windows 7)
0169b	LINUX API for g.MOBllab+	driver software package for g.MOBllab+; full access to recording buffer; for user specific applications on the PC; single place licence; prerequisite Ubuntu Linux 10.x , 32bit

Exchange data over networks between computers under MATLAB/SIMULINK

The exchange of data between different computer systems is important for many applications.

The g.UDPinterface for MATLAB/SIMULINK provides ready-to-use Simulink blocks and MATLAB functions to transmit data from a biosignal recording device to other applications like a Virtual Reality system or another MATLAB instance on another PC.

The g.UDPinterface can be used to exchange data between 2 Simulink applications running on two different PCs or notebooks.

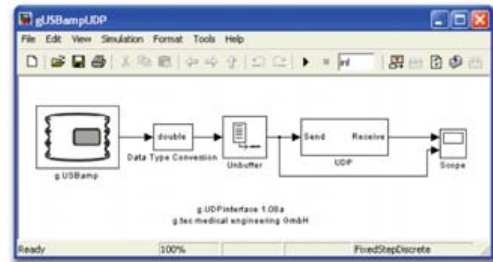
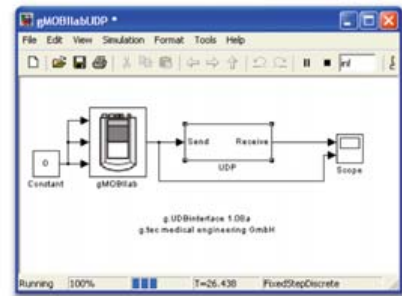
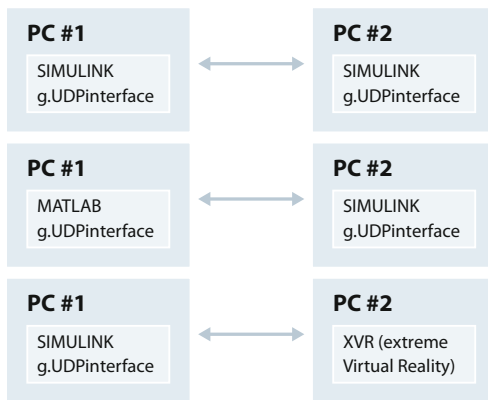

PRODUCT HIGHLIGHTS

- ◆ Exchange data between MATLAB/Simulink on two PCs over a standard network connection
- ◆ PCs are just connected with a normal network cable for data exchange
- ◆ The Simulink blocks can be used per drag-and-drop
- ◆ Fast data exchange with response time < 1ms
- ◆ Allows you to interface MATLAB with other software packages

SOFTWARE OPTIONS

Product no.	Product name	Description
0264	g.UDPinterface	data exchange with network connection between Simulink/MATLAB on different PCs (eg. BCI, VR, XVR, ...); single place licence; prerequisite MATLAB R2011a for OS English Win 32/64 (Windows 7), SIMULINK



Complete Systems



Complete research systems

g.tec provides complete research systems including all components required for the intended field of application. Smaller systems can be upgraded at any time. Demos and example applications allow an immediate start of work.



g.BCIsys
BCI RESEARCH SYSTEM

Development and research system for data acquisition, analysis, classification and neurofeedback

g.tec provides complete MATLAB-based development and research systems, including all hard- and software components needed for data acquisition, real-time and off-line data analysis, data set classification and providing neurofeedback.

A BCI system can be built with g.MOBllab+, g.USBamp, g.Hlamp or g.BSamp. g.MOBllab+ is available with up to 8 EEG channels with wireless signal transmission and is portable.

g.USBamp is available for 16-256 EEG channels and transmits the data over USB to the PC or notebook. g.Hlamp acquires 64 – 256 channels over USB. g.BSamp is available for 8, 16 to 80 channels.

With the software package High-Speed Online Processing under SIMULINK, you can read the biosignal data directly into SIMULINK. SIMULINK blocks are used to visualize and store the data. The parameter extraction and classification is performed either with standard SIMULINK blocks, with the g.RTanalyze library or with self-written S-functions.

After the EEG data acquisition the data can be analyzed with g.BSanalyze, the EEG and classification toolbox.

With ready-to-use BCI sample applications, you can make state-of-the-art BCI experiments within a few hours.

PRODUCT HIGHLIGHTS

- ◆ Complete BCI research system for EEG and ECoG
- ◆ Seamless integration of real-time experiments and off-line analysis
- ◆ Runs either with g.MOBllab+, g.USBamp, g.Hlamp or g.BSamp technology
- ◆ Ready to go paradigms for spelling, robot and cursor control
- ◆ Open source paradigms let you make adaptations and develop applications easily
- ◆ MATLAB/Simulink Rapid Prototyping environment speeds up development times from months to days
- ◆ BCI technology proven by hundreds of subjects and labs
- ◆ The only environment that supports all BCI concepts (Motor imagery, P300, SSVEP, SCP)

Brain-Computer Interface

A Brain-Computer Interface (BCI) provides a new communication channel between the human brain and a computer. Mental activity involves electrical activity, and these electrophysiological signals can be detected with techniques like the Electroencephalogram (EEG) or Electrocorticogram (ECoG). The BCI system detects such changes and transforms them into control signals, which can be used for moving objects, writing letters, opening doors, changing TV channels and other everyday household activities. This technology helps people with limited mobility increase their independence. One of the main goals is to enable completely paralyzed patients (locked-in syndrome) to communicate with their environment.

THE MAJOR TYPES OF BRAIN-COMPUTER INTERFACES

Motor Imagery

The subject imagines performing an action, like squeezing a ball. The EEG data are classified online, and the result is graphically presented to the subject as a horizontal bar on the screen that moves right if right hand motor imagery is detected or moves left if left hand motor imagery is detected. The continuous feedback helps the subject to train the motor imageries leading to a correct classification. To improve the performance the classifier should be updated after some successful sessions. Offline analysis of the recorded data supports feature optimization.

Example Applications: Motor Rehabilitation, Ping Pong

Recently BCI systems were also used for motor rehabilitation purposes for stroke patients. The BCI system is used to measure the activation of the sensorimotor cortex to control external supporting robotic devices such as exoskeletons or orthotic devices. The robotic device has the purpose to move the limbs of the patient and this activates again the sensorimotor cortex. The activation can be seen as ERD/ERS changes in the EEG signals. A motor imagery based BCI system is again able to measure this ERD/ERS changes and can use it as control signal. Common Spatial Patterns overlaying the whole sensorimotor cortex help to gain faster and more accurate control and weight each electrode according to its importance. Instead of real robotic devices also virtual representations of body limbs can be used to activate the mirror neurons. g.tec offers a complete BCI research bundle for rehabilitation including a 32 channel BCI system and a Virtual Reality projection system.

Everybody knows the famous Ping-Pong game that was played in the seventies on TV sets. In this example, two persons are connected to the BCI system and each one is controlling the paddle with motor imagery. The paddle moves upwards by left hand movement imagination and downwards by right hand movement imagination. The algorithm extracts EEG bandpower features in the alpha and beta ranges of two EEG channels per person. Therefore in total 4 EEG channels are analyzed and classified.

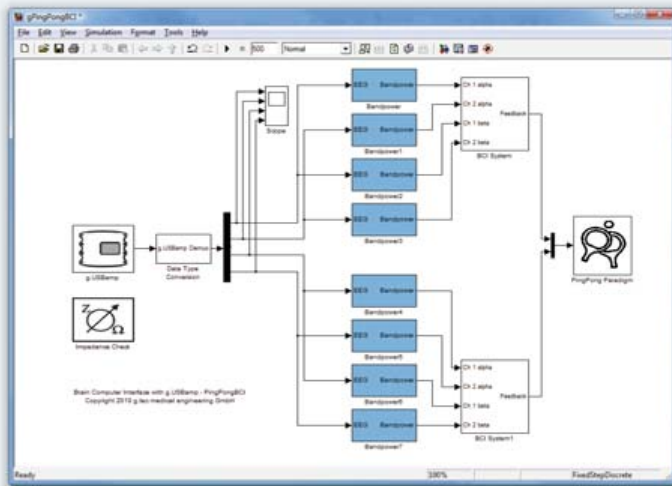

Example: The Pong Game. Two people are connected to a motor-imagery based BCI system. The positions of the rackets are controlled by movement imaginations of different limbs. E.g. a right hand motor imagery moves the racket upwards and a both-feet motor imagery moves it downwards. Gaming often helps to find out assets and drawbacks of a newly developed BCI method. The performance of a system is measured in terms of accuracy and speed.

THE MAJOR TYPES OF BRAIN-COMPUTER INTERFACES

P300

The P300 is another type of brain activity that can be detected with the EEG. The P300 is a brainwave component that occurs after a stimulus that is both important and relatively rare. In the EEG signal, the P300 appears as a positive wave 300 ms after stimulus onset. The electrodes are placed over the posterior scalp.

Example Applications: Spelling Device & Smart Home Device & Second Life

The P300 paradigm presents e.g. 36 letters in a 6 × 6 matrix on the computer monitor. Each letter (or row or column of letters) flashes in a random order, and the subject has to concentrate on the letter that he or she wants to communicate. As soon as the corresponding letter flashes, a P300 component is produced inside the brain. The algorithms analyze the EEG data and select the letter with the highest P300 component. Then, this letter is written onto the screen. Normally, between 2-15 flashes per letter are required to achieve a high accuracy. The number is dependent on many factors, including the electrode position used, the data processing parameters, and the individual height of the P300 response of the subject.

The BCI was connected to a Virtual Reality (VR) system. The virtual 3D representation of the smart home had different control elements (TV, music, windows, heating system, phone), and allowed the subjects to move through the apartment. Some tasks could be done, like playing music, watching TV, open doors, or moving around. Therefore, seven control masks were created: a light mask, a music mask, a phone mask, a temperature mask, a TV mask, a move mask and a "go to" mask. The controlling mask for the TV is shown.

g.tec implemented a BCI system based on the P300 principle. Therefore different symbols are arranged on a computer screen and are highlighted in a random order. If the subject focuses on one specific symbol that is flashing, the P300 should be elicited, and the BCI system can recognize this P300 and therefore the symbol. To control Second-Life, different masks (GUI with icons) were created for moving around, chatting, or other tasks specialized to each user's wishes.

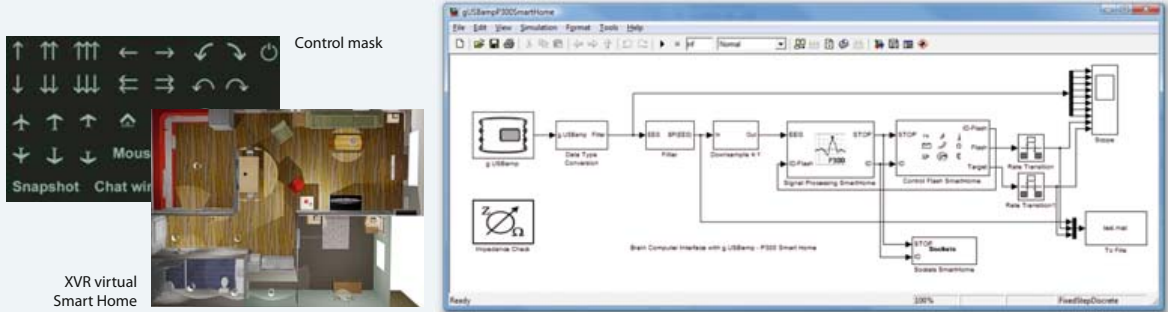

SSVEP – Steady State Visual Evoked Potential

SSVEP-based BCIs use several stationary oscillating light sources (e.g. flickering LEDs, or phase-reversing checkerboards), each of which oscillates at unique frequency. When a person gazes at one of these lights, or even focuses attention on it, then the EEG activity over the occipital lobe will show an increase in power at the corresponding frequency.

Example Applications: Robot movement control with SSVEP

With four choices, anyone could easily move a robot forwards, backwards, to the left and to the right. Hence, in our SSVEP BCI, we have four lights. (Of course, SSVEP BCIs have been developed with more or less than four lights, depending mainly on how many commands are required.) All the user has to do now is to look at one specific flickering light (for example, the one which is assigned to the "move forward"-command). Our algorithms determine which EEG frequency component(s) are higher than normal, which reveals which light the user saw and thus which movement command the user wanted to send. This system also uses a "no-control" state. When the user does not look at any oscillating light, the robot doesn't move.

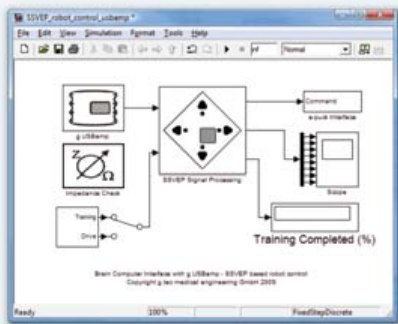

Product no.	Product name	Description
6006	g.BCIsys8MOBllab+: BCI research system, 8 EEG, NB included	consisting of: g.MOBllab+ 8 channel EEG version + Mini SD-card 1 GB; 10-pin connector box; g.MOBllab Simulink High-Speed Online Processing software; g.RTanalyze (software for online biosignal parameter extraction); g.BSanalyze (Base version + EEG toolbox + Classify toolbox for offline data processing, analysis and classification); Bluetooth dongle; fully equipped business notebook (with software ready-to-go installation); cables; bundle offer (5603+3014+5602+5012a+0111+0101+0102+0105+3016+3003); prerequisite MATLAB R2011a for OS English Win 32/64 (Windows 7), Signal Processing Toolbox, SIMULINK and Signal Processing Blockset
6014	g.BCIsys8MOBllab+ SSVEP, P300, NB included	consisting of: g.MOBllab+ 8 channel EEG version + Mini SD-card 1 GB; 10-pin connector box; g.MOBllab Simulink High-Speed Online Processing software; g.MOBllab+ P300 model; g.MOBllab+ SSVEP model and hardware; g.RTanalyze (software for online biosignal parameter extraction); g.BSanalyze (Base version + EEG toolbox + Classify toolbox for offline data processing, analysis and classification); Bluetooth dongle; fully equipped business notebook (with software ready-to-go installation); cables; bundle offer (6006+0139b+1303b); prerequisite MATLAB R2011a for OS English Win 32/64 (Windows 7), Signal Processing Toolbox, SIMULINK and Signal Processing Blockset
6007	g.BCIsysMOBllab+: BCI research system, multi-purpose, NB included	consisting of: g.MOBllab+ multi-purpose version (4 EEG/EOG, 2 ECG/EMG, 2 analog inputs, digital I/Os) + Mini SD-card 1 GB; 9-pin connector box; g.MOBllab Simulink High-Speed Online Processing software; g.RTanalyze (software for online biosignal parameter extraction); g.BSanalyze (Base version + EEG toolbox + Classify toolbox for offline data processing, analysis and classification); Bluetooth dongle; fully equipped business notebook (with software ready-to-go installation); cables; bundle offer (5033+3014+5003+5012a+0111+0101+0102+0105+3016+3003); prerequisite MATLAB R2011a for OS English Win 32/64 (Windows 7), Signal Processing Toolbox, SIMULINK and Signal Processing Blockset
6011	g.BCIsys8MOBllab+: P300, 8 EEG, NB included	consisting of: g.MOBllab+ 8 channel EEG version + Mini SD card 1 GB; 10-pin connector box; g.MOBllab Simulink High-Speed Online Processing software; g.BSanalyze (Base version + EEG toolbox + Classify toolbox for offline data processing, analysis and classification); Bluetooth dongle; fully equipped business notebook (with software ready-to-go installation); cables; bundle offer for P300 experiments (5603+3014+5602+5012a+0101+0102+0105+3016+3003); prerequisite MATLAB R2011a for OS English Win 32/64 (Windows 7), Signal Processing Toolbox, SIMULINK and Signal Processing Blockset
6023	g.BCIsys16USB: complete BCI-research system, PC included	16 channels; consisting of: g.USBamp (biosignal amplifier, CE-certified, FDA approved, with power supply); SIMULINK HIGH-SPEED ONLINE Processing software (drivers and blockset for SIMULINK); g.RTanalyze (real-time software for biosignal parameter extraction); g.BSanalyze (base version + EEG-toolbox + Classify-toolbox for offline data processing, analysis and classification); fully equipped business PC (with software ready-to-go installation); bundle offer (0216+0282+5051+0247+0260+0111+0101+0102+0105+3001a); prerequisite MATLAB R2011a for OS English Win 32/64 (Windows 7), Signal Processing Toolbox, SIMULINK and Signal Processing Blockset
6029	g.BCIsys16USB, PC included ERD, SSVEP, P300	16 channels; consisting of: g.USBamp (biosignal amplifier, CE-certified, FDA approved, with power supply); SIMULINK HIGH-SPEED ONLINE Processing software (drivers and blockset for SIMULINK); g.RTanalyze (real-time software for biosignal parameter extraction); g.USBamp P300 model; g.USBamp Ping Pong model; g.USBamp SSVEP model and hardware; g.BSanalyze (base version + EEG-toolbox + Classify-toolbox for offline data processing, analysis and classification); fully equipped business PC (with software ready-to-go installation); bundle offer (6023+0139a+0140a+1303a); prerequisite MATLAB R2011a for OS English Win 32/64 (Windows 7), Signal Processing Toolbox, SIMULINK and Signal Processing Blockset
6024	g.BCIsys32USB: complete BCI-research system, PC included	32 channels; consisting of: g.USBamp (biosignal amplifier, double unit, CE-certified, FDA approved, with power supply); SIMULINK HIGH-SPEED ONLINE Processing software (drivers and blockset for SIMULINK); g.RTanalyze (real-time software for biosignal parameter extraction); g.BSanalyze (base version + EEG-toolbox + Classify-toolbox for offline data processing, analysis and classification); fully equipped business PC (with software ready-to-go installation); synchronisation cable; USB 2.0 Hub; bundle offer (2x0216+2x0282+2x5051+0247b+0260+0111+0101+0102+0105+3001a+0281+0284); prerequisite MATLAB R2011a for OS English Win 32/64 (Windows 7), Signal Processing Toolbox, SIMULINK and Signal Processing Blockset
6031	g.BCIsys32USB ERD, SSVEP, P300, PC included	32 channels; consisting of: g.USBamp (biosignal amplifier, double unit, CE-certified, FDA approved, with power supply); SIMULINK HIGH-SPEED ONLINE Processing software (drivers and blockset for SIMULINK); g.USBamp P300 model; g.USBamp Ping Pong model; g.USBamp SSVEP model and hardware; g.USBamp common spatial patterns; g.RTanalyze (real-time software for biosignal parameter extraction); g.BSanalyze (base version + EEG-toolbox + Classify-toolbox for offline data processing, analysis and classification); fully equipped business PC (with software ready-to-go installation); synchronisation cable; USB 2.0 Hub; bundle offer (6024+0139a+0140a+0142+1303a); prerequisite MATLAB R2011a for OS English Win 32/64 (Windows 7), Signal Processing Toolbox, SIMULINK and Signal Processing Blockset
6021	g.BCIsys64USB: complete BCI-research system, PC included	64 channels; consisting of: g.USBamp (biosignal amplifier, quadruple unit, CE-certified, FDA approved, with power supply); SIMULINK HIGH-SPEED ONLINE Processing software (drivers and blockset for SIMULINK); g.RTanalyze (real-time software for biosignal parameter extraction); g.BSanalyze (base version + EEG-toolbox + Classify-toolbox for offline data processing, analysis and classification); fully equipped business PC (with software ready-to-go installation); synchronisation cable; USB 2.0 Hub; bundle offer (4x0216+4x0282+4x5051+0247a+0260+0111+0101+0102+0105+3001a+0283+0284); prerequisite MATLAB R2011a for OS English Win 32/64 (Windows 7), Signal Processing Toolbox, SIMULINK and Signal Processing Blockset
6032	RehaBCI, PC included	32 channels; consisting of: g.BCIsys32USB; g.VRsys; g.GAMMAbundle for g.USBamp CSP; g.UDPInterface for communication between the PCs; g.USBamp common spatial patterns model; bundle offer; (6024+0299+1111b+0264+0299)
8006	g.Hlamp package BCI	upgrade for BCI research consisting of: g.Hlamp SIMULINK HIGH-SPEED ONLINE Processing Software (drivers and blocksets for SIMULINK); g.Hlamp P300 model; g.Hlamp Ping Pong model; g.Hlamp SSVEP model; g.Hlamp common spatial patterns; g.RTanalyze (real-time software for biosignal parameter extraction); g.BSanalyze (Base version + EEG toolbox + Classify toolbox for offline data processing, analysis and classification); bundle offer (0260d, 0139d, 0140d, 0141d, 0142b, 0111, 0101, 0102, 0105)

University/education prices available



BCI research system based on g.tec's hardware and BCI2000 open source research platform

A Brain-Computer Interface (BCI) provides a new communication channel between the brain and the computer. Mental activity leads to changes of electrophysiological signals like the electroencephalogram (EEG) or the electrocorticogram (ECoG). The BCI system detects such changes and transforms them into control signals that can, for example, be used to spell words or to control a cursor on a computer screen. One of the main goals of BCI research is to make it possible for completely paralyzed patients (locked-in syndrome) to communicate with their environments.

BCI2000 is a general-purpose system for BCI research and development. It can also be used for data acquisition, stimulus presentation, or brain observation applications. BCI2000 has been in development since

2000 in a collaborative effort led by the Wadsworth Center, Albany, New York, USA. BCI2000 has been used to replicate or extend current BCI methods in humans, and has recently been used in a number of groundbreaking BCI studies. BCI2000 is available free of charge for research purposes to academic and educational institutions (see www.bci2000.org for further information). g.tec is offering complete certified BCI2000 systems with optimally configured components.

g.tec's biosignal amplifiers (g.USBamp and g.MOBIlab+) are fully supported by the BCI2000 platform and have passed various performance tests. g.tec provides ready-to-go installed systems with high-end hardware that can be extended easily with all g.tec research software components at your convenience.

PRODUCT HIGHLIGHTS

- ◆ g.tec offers a system that is certified for BCI2000 that contains all necessary components for a fast and hassle-free setup and first session
- ◆ can be used to run BCI experiments with P300 and motor imagery
- ◆ the g.tec amplifiers are seamlessly integrated into BCI2000
- ◆ offers several signal processing methods and lets users interface the system with a number of different output devices
- ◆ satisfies the real-time requirements of BCI systems
- ◆ facilitates the implementation of different BCI systems
- ◆ is available with full documentation and free of charge for research or educational purposes
- ◆ is currently being used in a variety of studies by more than 300 research groups

COMPLETE SOLUTIONS

Product no.	Product name	Description
6012	g.tec BCI2000 bundle offer with g.MOBIlab+, NB included	consisting of g.MOBIlab+ EEG version + Mini SD card 1 GB; 10-pin connector; g.MOBIlab+ C API + BCI2000 driver, BCI2000 software package; fully equipped business notebook (with ready to go installation); bundle offer (5603+3014+5602+5011a+3016+3003)
6028	g.tec BCI2000 bundle offer with g.USBamp, NB included	consisting of: g.USBamp (16 channel biosignal amplifier, CE-certified, FDA approved, with power supply); water-proof heavy duty case; USB cable; fully equipped business notebook; CAPI and BCI2000 driver, BCI2000 driver package; bundle offer (0216+5051+0282+0247+3003+0263a)

A complete EEG research system, ready-to-go installation on a PC or notebook

Start immediately with EEG research! We provide various complete EEG-research packages with 8 to 64 channels to meet your research needs. The systems include amplifier(s), acquisition software, analysis software and a high-end business PC or notebook with all the software installed and ready to go. Just add your desired sensors, caps, electrodes and consumables and establish your lab!

g.Recorder enables easy amplifier configuration, data visualization and storage. Triggers and markers can





be assigned and recorded; data can also be reviewed. For data analysis, g.EEGsys packages include g.BSanalyze (base version plus EEG toolbox).

Systems based on g.USBamp can be upgraded for more channels at any time. All g.tec systems can be used with active or passive electrodes. Upgrading the system for real-time processing/BCI research is also no problem at all.

PRODUCT HIGHLIGHTS

- ◆ The complete solution for your lab
- ◆ All software already installed and tested on a high end business PC/notebook
- ◆ Based on g.MOBllab+ (8 channels) or g.USBamp (16-64 ch.)
- ◆ Includes g.Recorder data acquisition software
- ◆ Includes g.BSanalyze offline analysis software (base version + EEG toolbox)
- ◆ Can be upgraded to a real-time/BCI system at any time

COMPLETE SOLUTIONS

Product no.	Product name	Description
6070 	g.EEG16sys, complete portable EEG recording/analysis system, NB included	consisting of: g.USBamp (16 channel biosignal amplifier, CE-certified, FDA approved, with power supply); g.Recorder + camera; g.BSanalyze (base version) for offline data visualization/processing and EEG-Toolbox for advanced EEG analysis; fully equipped business notebook (with software ready-to-go installation); bundle offer (0216+0282+5051+0247+0167a+0287+0101+0102+3003); prerequisite MATLAB R2011a for OS English Win 32/64 (Windows 7), Signal Processing Toolbox
6080 	g.EEG32sys, complete EEG recording/analysis system, PC included	consisting of: g.USBamp (32 channel biosignal amplifier, CE-certified, FDA approved, with power supply); g.Recorder; g.BSanalyze (base version) for offline data visualization/processing and EEG-Toolbox for advanced EEG analysis; fully equipped business PC (with software ready-to-go installation); synchronisation cable; USB 2.0 Hub; bundle offer (2x0216+2x0282+2x5051+0247b+0167a+0287+0101+0102+3001a+0281+0284); prerequisite MATLAB R2011a for OS English Win 32/64 (Windows 7), Signal Processing Toolbox
6090 	g.EEG64sys, complete EEG recording/analysis system, PC included	consisting of: g.USBamp (64 channel biosignal amplifier, CE-certified, FDA approved, with power supply); g.Recorder; g.BSanalyze (base version) for offline data visualization/processing and EEG-Toolbox for advanced EEG analysis; fully equipped business PC (with software ready-to-go installation); synchronisation cable; USB 2.0 Hub; bundle offer (4x0216+4x0282+4x5051+0247a+0167a+0287+0101+0102+3001a+0283+0284); prerequisite MATLAB R2011a for OS English Win 32/64 (Windows 7), Signal Processing Toolbox
6008 	g.EEGsys g.MOBllab+ multi-purpose version, NB included	consisting of g.MOBllab+ (4 EEG/EOG, 2 ECG/EMG, 2 analog inputs, digital I/Os) + Mini SD-card 1 GB; 9-pin connector box; g.Recorder; g.BSanalyze (Base version + EEG toolbox for offline data processing); 5 lead ECG/EMG patient cable; Bluetooth dongle; fully equipped business notebook (with software ready-to-go installation); cables; bundle offer (5033+3014+5003+0167b+0101+0102+5002+3016+3003); prerequisite MATLAB R2011a for OS English Win 32/64 (Windows 7), Signal Processing Toolbox
6009 	g.EEGsys g.MOBllab+ 8 channel EEG version, NB included	consisting of: g.MOBllab+ 8 channel EEG version + Mini SD-card 1 GB; 10-pin connector box; g.Recorder; g.BSanalyze (Base version + EEG toolbox for offline data processing); Bluetooth dongle; fully equipped business notebook (with software ready-to-go installation); cables; bundle offer (5603+3014+5602+0167b+0101+0102+3016+3003); prerequisite MATLAB R2011a for OS English Win 32/64 (Windows 7), Signal Processing Toolbox

 University/education prices available

The first EEG based spelling device for patients' everyday use



intendiX is a novel, user-friendly software and hardware package providing an EEG-based spelling system. intendiX lets users choose and write symbols from a symbol collection presented on the screen just by paying attention to the symbol the user wants to communicate.

g.tec provides intendiX systems for rent to test the system at the patient's site before deciding about a purchase.



To control external devices a special extension tool called "extendiX" serves as an interface. extendiX runs on a separate computer that controls other devices/ applications such as TV, music, assistive robots, games and many more. extendiX just receives commands from intendiX via UDP and starts/executes the corresponding application or batch.

See also www.intendiX.com

PRODUCT HIGHLIGHTS

- ◆ Complete solution comes with all required hardware and software components
- ◆ Designed to be operated by caregivers or the patient's family at home
- ◆ Based on the well known P300 component of visual evoked EEG potentials
- ◆ Intelligently detects idle state of a person
- ◆ Runs with g.MOBilab+ and/or g.USBamp technology
- ◆ Highly customizable symbol collection and operation modes
- ◆ Train and store classifiers for individuals within several minutes
- ◆ Merge existing classifiers that were previously trained with several individuals to get a more general (universal) classifier
- ◆ Reads brain-written text aloud via the Microsoft Windows operating system's built-in Text-To-Speech engine
- ◆ Allows third-party applications to customize reactions to each symbol selection

COMPLETE SOLUTIONS

Product no.	Product name	Description
6040 	intendiX g.MOBilab+ EEG Version, NB included	consisting of: g.MOBilab+ EEG version; Bluetooth dongle; notebook; heavy duty case; g.GAMMAcap2 size M; g.GAMMAcap2BELT; g.GAMMAearclip Au; 8x g.BUTTERFLY; g.GAMMAbox; g.MOBilab+GAMMAconnector; g.BUTTERFLYgnd; 3x g.GAMMAgel and intendiX software; bundle offer (5603+3016+3003+5050+1023m+1028+1038+8*1036+1016a+1019b+1037+3*1021+6043)
6044 	intendiX g.USBamp, NB included	consisting of: g.USBamp 8 channels; notebook; heavy duty case; g.GAMMAcap2 size M; g.GAMMAcap2BELT; g.GAMMAearclip Au; 8x g.BUTTERFLY; g.GAMMAbox; g.USBampGAMMAconnector; g.BUTTERFLYgnd; 3x g.GAMMAgel and intendiX software; bundle offer (0230+0247+3003+1023m+1028+1038+8*1036+1016a+1019a+1037+3*1021+6043)
6043	intendiX software	single place licence
 System rental options available		

 Electrodes and
Electrode Systems





g.[®] **EEGcap**
EEG ELECTRODE CAP

A golden
standard
for decades

The g.EEGcap system has a long history. It was invented about 20 years ago and is used in hundreds of labs worldwide. In research, it is very popular due to its unique mechanism and robust design. A big advantage of the cap is that it uses individual electrodes for maximum electrode montage flexibility. With g.EEGcap, it is easy to configure new experimental setups, and the cap will always allow you to place each electrode where you need it.

The g.EEGcap has 65 electrodes positions and has bayonet sockets to adjust the distance between the electrode and the skin for optimal impedance values. This also guarantees that the electrodes system works perfectly for different head shapes and different hair styles. The 12-mm openings provide excellent access

to the skin for perfect skin preparation with abrasive gel and ultra-low impedance recordings. The gel is applied to the skin before the electrode is inserted. After the measurement, the electrodes are removed. Gold and Ag/AgCl electrodes are available as well as active sintered electrodes to be used with the g.GAMMAsys active electrode system.

The caps are available in sizes S (50 - 54 cm), M (54 - 58 cm) and L (58 - 62) where the L-sized cap fits at least 80 % of adult subjects. Other sizes, plain caps without electrode sockets and customized electrode positions are available on request.

Each cap comes with a fixation belt set (chest belt) and a measuring tape for correct cap placement.

PRODUCT HIGHLIGHTS

- ◆ robust design and unique screw-lock electrode montage
- ◆ maximum flexibility due to single electrodes
- ◆ adjustable distance between the electrode and the skin
- ◆ active and passive electrodes can be used
- ◆ easy access to the skin for perfect skin preparation
- ◆ extended 10-20 system
- ◆ additional electrode positions are possible

CAPS

Product no.	Product name	Description
1003s	g.EEGcap, 65 positions, S	electrode cap with 65 electrode positions; extended 10/20 system; size: S (50-54 cm); incl. fixation belts and measuring tape
1003m	g.EEGcap, 65 positions, M	electrode cap with 65 electrode positions; extended 10/20 system; size: M (54-58 cm); incl. fixation belts and measuring tape
1003l	g.EEGcap, 65 positions, L	electrode cap with 65 electrode positions; extended 10/20 system; size: L (58-62 cm); incl. fixation belts and measuring tape
1029	plain g.EEGcap	black electrode cap; without plastic rings; available in S, M and L
1110	bundle offer: Cap Set (3 pieces)	g.EEGcap, 65 positions, size S + M + L; 70 pieces g.EEGelectrodes Au; 10 pieces EEG-electrodes gold; 1 x abrasive gel; 1 x Elefix gel; incl. fixation belts, measuring tape; bundle offer (1003s/m/l+70x1001+1002+1031+1030)
1112a	active g.EEGcap bundle for g.USBamp	consisting of 1x g.EEGcap (incl. fixation belts, measuring tape), 65 positions, size L; 18x g.ACTIVEelectrodes; 1x g.ACTIVEground; 1x g.GAMMAearclip Ag/AgCl; 1x g.GAMMAbox; 1 g.USBampGAMMAconnector; 5x g.GAMMAgel (1003l+18x1015+1018+1039+1016c+1019a+5x1021)
1112b	active g.EEGcap bundle for g.MOBllab+ EEG version	consisting of 1x g.EEGcap (incl. fixation belts, measuring tape), 65 positions, size L; 10x g.ACTIVEelectrodes; 1x g.ACTIVEground; 1x g.GAMMAearclip Ag/AgCl; 1x g.GAMMAbox; 1 g.MOBllab+GAMMAconnector; 5x g.GAMMAgel (1003l+9x1015+1018+1039+1016c+1019b+5x1021)
1014	customized electrode position	confirmation of availability and lead time on request before order

ELECTRODES



Product no.	Product name	Description
1001	g.EEGelectrode Au	screwable passive gold EEG electrode, suitable for g.EEGcap, 100 cm lead, 1.5 mm safety connector, produced for long-term use and maintenance free, color: green, black, red, white
1004	g.EEGelectrode Ag/AgCl	screwable passive Ag/AgCl EEG electrode (for DC recordings), suitable for g.EEGcap, 100 cm lead, 1.5 mm safety connector, produced for long-term, must be chlorinated, color: green, black, red, white
1018	g.ACTIVEground	screwable passive ground electrode, fits into standard g.EEGcaps, sintered Ag/AgCl crown (for DC recordings), 125 cm lead, 2-pin safety
1015	g.ACTIVEelectrode	screwable active EEG electrode, fits into standard g.EEGcaps, sintered Ag/AgCl crown (for DC recordings), 125 cm lead, 2-pin safety



Product no.	Product name	Description
1101	Ear-clip electrode Au	gold; to apply at the earlobes; 2 pieces



Product no.	Product name	Description
1039	g.GAMMAearclip Ag/AgCl	active earclip Ag/AgCl electrode (reference), sintered Ag/AgCl crown, 125 cm lead, 2-pin safety connector, color: blue

g.GAMMAcap²

ACTIVE/PASSIVE/DRY EEG ELECTRODE CAP

Quick, comfortable,
active/passive/dry



The second generation of g.GAMMAcap: new optimized cut for perfect fit, new highly flexible super-narrow seams for high-density electrode placement, 74 labeled standard positions (10-10/extended 10-20 system) plus 86 additional intermediate positions, can now be used either with a chest belt set or with a chin strap that comes with each cap. Size M fits most adult subjects, but a cap set includes sizes S, M and L.

The g.GAMMAcap² can be configured with active electrodes for a certain experiment (such as the P300 speller), and the electrodes remain inside the cap even during cleaning. This allows a very fast preparation and cleaning procedure, which speeds up experi-

ments considerably. A typical setup time for a P300 speller experiment (10 electrodes) is about 2 minutes - just put on the cap and inject the gel. After the cap is removed, the gel almost disappears after drying.

g.GAMMAsys was designed to increase the speed of EEG/ECG/EMG/EOG experimental setups, while still using a comfortable cap and a very high signal quality.

g.GAMMAsys includes different types of active and passive electrodes that can be mounted with the g.GAMMAcap² onto the head for EEG recordings or can be mounted on the body for ECG/EMG/EOG recordings.

PRODUCT HIGHLIGHTS

- ◆ Avoid or reduce artifacts from movements and electromagnetic interference
- ◆ Fastest electrode montage for multi-channel recordings
- ◆ System can be used with passive, active or dry electrodes
- ◆ Single electrodes can be replaced easily
- ◆ Electrodes remain in the cap for cleaning, which allows fast montage and cleaning
- ◆ 74 standard + 86 intermediate positions; user can add positions freely

CAPS AND BUNDLES

Product no.	Product name	Description
1023s	g.GAMMAcap2, 74 position, S	electrode cap with 74 standard and 86 intermediate position; extended 10/10 system; size: S (50-54 cm), additional positions can be added freely by the user; chin strap
1023m	g.GAMMAcap2, 74 position, M	electrode cap with 74 standard and 86 intermediate position; extended 10/10 system; size: M (54-58 cm), additional positions can be added freely by the user; chin strap
1023l	g.GAMMAcap2, 74 position, L	electrode cap with 74 standard and 86 intermediate position; extended 10/10 system; size: L (58-62 cm), additional positions can be added freely by the user; chin strap
1026	plain g.GAMMAcap2	The cap can also be ordered without any electrode cuts. A knife can be used to cut electrode positions to design your own configuration; chin strap
1027	g.GAMMAcap2SET	set of 3 caps (size S, M, L), 74 standard and 86 intermediate positions according to the international 10/10 system, additional positions can be added freely by the user, one chest belt set
1028	g.GAMMAcap2BELT	chest belt set, flexible velcro chest belt (90 - 150 cm), 2 adjustable strips for g.GAMMAcap2, measuring tape, syringe
1111	g.GAMMAbundle for g.USBamp	consisting of g.GAMMAcap2SET; 17x g.LADYbird; 2x g.LADYbirdGND; 2x g.GAMMAearclip Ag/AgCl; 5x g.GAMMAgel; 1x g.GAMMAbox for 16 channels; 1x g.USBampGAMMAconnector (1027+17*1033+2*1034+2*1039+5*1021+1016a+1019a)
1111b	g.GAMMAbundle for g.USBamp CSP	consisting of g.GAMMAcap2SET; 33 x g.LADYbird; 2x g.LADYbirdGND; 2x g.GAMMAearclip Ag/AgCl; 5x g.GAMMAgel; 1x g.GAMMAbox for 16 channels; 1x g.EXTENSIONbox for g.GAMMAbox for additional 16 channels; 2x g.USBampGAMMAconnector (1027+33x1033+2x1034+2x1039+5x1021+1016a+1022+2x1019a)
1114	g.GAMMAbundle for g.MOBilab+ 8 channel EEG version	consisting of g.GAMMAcap2SET; 9x g.LADYbird; 2x g.LADYbirdGND; 2x g.GAMMAearclip Ag/AgCl; 5x g.GAMMAgel; 1x g.GAMMAbox for 16 channels; 1x g.MOBilab+GAMMAconnector (1027+9*1033+2*1034+2*1039+5*1021+1016a+1019b)

LADYBIRD AND EARCLIP



Product no.	Product name	Description
1035	g.LADYbirdPASSIVE	passive ring electrode, can be used with g.GAMMAcap2 (EEG) or with adhesive washer (ECG, EMG, EOG), sintered Ag/AgCl ring (for DC recordings), 120 cm lead, 1.5 mm safety connector, remains in the cap for skin preparation and cleaning
1033	g.LADYbird	active ring electrode, can be used with g.GAMMAcap2 (EEG) or with adhesive washer (ECG, EMG, EOG), sintered Ag/AgCl crown (for DC recordings), 125 cm lead, 2-pin safety connector, remains in the cap for cleaning, color: red
1034	g.LADYbirdGND	passive ground ring electrode, can be used with g.GAMMAcap2 (EEG) or with adhesive washer (ECG, EMG, EOG), sintered Ag/AgCl crown (for DC recordings), 125 cm lead, 2-pin safety connector, remains in the cap for cleaning, color: yellow
1039	g.GAMMAearclip Ag/AgCl	active earclip Ag/AgCl electrode (reference), sintered Ag/AgCl crown, 125 cm lead, 2-pin safety connector, color: blue

BUTTERFLY AND EARCLIP



Product no.	Product name	Description
1036	g.BUTTERFLY	active electrode, for use with g.GAMMAcap2, high-purity gold crown, 125 cm lead, 2-pin safety connector, remains in the cap for cleaning, color: red
1037	g.BUTTERFLYgnd	passive electrode, for use with g.GAMMAcap2, high-purity gold crown, 125 cm lead, 2-pin safety connector, remains in the cap for cleaning, color: yellow
1038	g.GAMMAearclip Au	active gold electrode earclip (reference), high-purity gold crown, 125 cm lead, 2-pin safety connector, color: blue

CLIPS



Product no.	Product name	Description
1024	g.GAMMAclip	active clip connector for use with disposable pre-gelled adhesive electrodes for ECG/EMG/EGG/..., 150 cm lead, 2-pin safety connector, color: red
1025	g.GAMMAclipGND	passive ground clip connector for use with disposable pre-gelled adhesive electrodes for ECG/EMG/EGG/..., 150 cm lead, 2-pin safety connector, color: yellow
1047	g.GAMMAclipREF	active clip connector (reference) for use with disposable pre-gelled adhesive electrodes for ECG/EMG/EGG/..., 150 cm lead, 2-pin safety connector, color: blue

GAMMABOX AND CABLES



Product no.	Product name	Description
1016a	g.GAMMABOX for 16 channels, DC	power supply & driver/interface box for 16 active electrodes, DC coupled for usage with g.USBamp, works with g.tec 2-pin safety connector electrodes
1016c	g.GAMMABOX for 16 channels, AC	power supply & driver/interface box for 16 active electrodes, AC coupled for usage with g.USBamp, g.BSamp and g.MOBilab; works with g.tec 2-pin safety connector electrodes
1019a	g.USBampGAMMAconnector	connector cable between the g.USBamp (system connector) and the g.GAMMABOX; 40 cm lead
1019b	g.MOBilab+GAMMAconnector	connector cable between the g.MOBilab+ 8 channel EEG version (system connector to 8 EEG channels) and the g.GAMMABOX; 40 cm lead
1019c	g.BSampGAMMAconnector	connector cable between the g.BSamp (1.5 mm touch proof) and the g.GAMMABOX; 40 cm lead
1019d	g.CustomizedGAMMAconnector	connector cable between a third party amplifier and the g.GAMMABOX; 84 cm lead, confirmation of availability on request before order;
1019e	g.MOBilab+GAMMAconnector for MP, EEG/EOG	connector cable between the g.MOBilab+ multi-purpose version (system connector to 4 EEG/EOG channels) and the g.GAMMABOX for bipolar recordings; 40 cm lead
1019g	g.MOBilab+GAMMAconnector for MP EEG/EOG and ECG/EMG	connector cable between g.MOBilab+ multi-purpose version (system connector to 4 EEG/EOG channels and 2 ECG/EMG channels) and the g.GAMMABOX for bipolar recordings; 40 cm lead
1022	g.EXTENSIONBOX for g.GAMMABOX	for additional 16 active electrodes; without ground and reference

Dry like the desert



Normally, the electroencephalogram (EEG) is recorded from the surface of the head with gel based electrodes to get a low electrode-skin impedance. If passive electrodes are used, the skin must be abraded beforehand to reduce the impedance. With active electrodes, which contain an amplifier inside, the electrode gel is injected between the electrode material and the skin. This allows a faster montage of the electrode system.

One of the main advantages of gel based active electrodes is their robust behavior, but the main disadvantages are the long montage time and the need to wash the user's hair after the recording. g.tec thus developed a dry electrode system which does not require electrode gel. The g.SAHARA electrode system (patent pending) consists of an 8 pin electrode

made of a special gold alloy. The pins have sufficient length to reach through the hair to the skin. The material and the 8 pins reduce the electrode-skin impedance. The electrode itself can be connected with a clip to the active electrode system on top of it.

EEG recordings are performed at frontal, central, parietal and occipital regions of the head, and therefore a mechanical system is required that holds the electrode to the skin with a constant pressure at every possible recording location. EEG electrodes are typically positioned according to the international 10/20 system. g.tec hence developed the 2nd generation of the g.GAMMAcap, with a total of 160 positions according to an extended 10/20 system, to allow a very flexible electrode montage

PRODUCT HIGHLIGHTS

- ◆ The first and only dry electrode system that works for all frontal, central, occipital and parietal sites
- ◆ The first dry active electrode already available on the market
- ◆ The first and only dry system tested with all major BCI concepts in group studies with success
- ◆ Cost range of an active EEG electrode
- ◆ Captures the whole EEG frequency spectrum from 0.1-40 Hz
- ◆ Perform EEG recordings without gel
- ◆ Mount the cap in under one minute!
- ◆ Washing hair is no longer required!
- ◆ Able to pick up frequency spectra for P300, motor imagery and SSVEP based BCIs

SAHARASYS ELECTRODES AND CLIPS



Product no.	Product name	Description
1070a	g.SAHARAElectrode, 7 mm	dry electrode, 8 gold-alloy coated pins with 7 mm length, 19 mm diameter, clip connector on top to connect to g.SAHARAclip, color:
1070b	g.SAHARAElectrode, 16 mm	dry electrode, 8 gold-alloy coated pins with 16 mm length, 19 mm diameter, clip connector on top to connect to g.SAHARAclip, color:
1071	g.SAHARAclip	active clip connector for use with g.SAHARAElectrode, 125 cm lead, 2 pin safety connector, color: orange
1072	g.SAHARAclipREF	active clip connector for use with disposable adhesive mastoid electrodes, 125 cm lead, 2 pin safety connector, color: blue
1073	g.SAHARAclipGND	passive clip connector for use with disposable adhesive mastoid electrodes, 125 cm lead, 2 pin safety connector, color: yellow

SAHARABOX AND CONNECTORS TO THE AMPLIFIERS

Product no.	Product name	Description
1074	g.SAHARAbOX	power supply & driver/interface box for 16 g.SAHARAElectrodes, for usage with all g.tec amplifiers, frequency range 0.1 Hz - 40 Hz
1076	g.SAHARAbOXCONNECTOR for g.USBamp	connector cable to connect g.SAHARAbOX to g.USBamp, 16 channels
1077	g.SAHARAbOXCONNECTOR for g.MOBilab+	connector cable to connect g.SAHARAbOX to g.MOBilab+, 8 channels (EEG version)
1078	g.SAHARAbOXCONNECTOR for g.BSamp	connector cable to connect g.SAHARAbOX to g.BSamp, 16 channels (monopolar)
1079	g.SAHARASet 8, for g.USBamp	consisting of g.GAMMAcap2SET; 8x g.SAHARAElectrode, 7mm; 8x g.SAHARAElectrode, 16mm; 8x g.SAHARAclip; 2x g.SAHARAclipREF; 2x g.SAHARAclipGND; 1x g.SAHARAbOX; 1x g.SAHARAbOXCONNECTOR for g.USBamp; 2x adhesive mastoid electrodes (100 pcs) (1027 + 8x1070a + 8x1070b + 8x1071 + 2x1072 + 2x1073 + 1x1074 + 2x1075 + 1x1076)
1080	g.SAHARASet 8, for g.MOBilab+	consisting of g.GAMMAcap2SET; 8x g.SAHARAElectrode, 7mm; 8x g.SAHARAElectrode, 16mm; 8x g.SAHARAclip; 2x g.SAHARAclipREF; 2x g.SAHARAclipGND; 1x g.SAHARAbOX; 1x g.SAHARAbOXCONNECTOR for g.MOBilab; 2x adhesive mastoid electrodes (100 pcs) (1027 + 8x1070a + 8x1070b + 8x1071 + 2x1072 + 2x1073 + 1x1074 + 2x1075 + 1x1077)
1081a	g.SAHARASet 16, for g.USBamp, 7mm	consisting of g.GAMMAcap2SET; 16x g.SAHARAElectrode, 7mm; 16x g.SAHARAclip; 2x g.SAHARAclipREF; 2x g.SAHARAclipGND; 1x g.SAHARAbOX; 1x g.SAHARAbOXCONNECTOR for g.USBamp; 2x adhesive mastoid electrodes (100 pcs) (1027 + 16x1070a + 16x1071 + 2x1072 + 2x1073 + 1x1074 + 2x1075 + 1x1076)
1081b	g.SAHARASet 16, for g.USBamp, 16mm	consisting of g.GAMMAcap2SET; 16x g.SAHARAElectrode, 16mm; 16x g.SAHARAclip; 2x g.SAHARAclipREF; 2x g.SAHARAclipGND; 1x g.SAHARAbOX; 1x g.SAHARAbOXCONNECTOR for g.USBamp; 2x adhesive mastoid electrodes (100 pcs) (1027 + 16x1070b + 16x1071 + 2x1072 + 2x1073 + 1x1074 + 2x1075 + 1x1076)

MISC CABLES AND ELECRODES



Product no.	Product name	Description
1002	EEG-electrode Au	10 pieces; disk electrodes; electrode length 150 cm; 10 mm diameter
1044	EOG sintered electrode, 14 mm	sintered Ag/AgCl electrode; diameter 14 mm; cable length: 150 cm, safety connector
1009	ECG electrode cable with clip lead	3 leads/piece; 150 cm length; for disposable electrodes

CONSUMABLES



Product no.	Product name	Description
1021	g.GAMMAgel	special highly conductive high-viscosity electrode gel for g.GAMMAsys active electrodes, water-soluble, non-abrasive, non-greasy, non-irritant, non-corrosive, CE class 1 product, in doser can, 200g, easy insertion through electrode holes; incl. syringe
1060	g.GAMMAgelSET	10 * g.GAMMAgel (1021)
1050	g.GAMMAcream	special highly conductive high-viscosity electrode cream for long-term recording with g.GAMMAsys active electrodes, water-soluble, non-abrasive, non-greasy, non-irritant, non-corrosive, CE class 1 product, in doser can, 200g, easy insertion through electrode holes; incl. syringe
1030	Elefix	electrode paste for optimal low impedances; 400 g
1031	abrasive gel	to prepare the skin before EEG measurements; 500 g
1075	Adhesive mastoid electrodes	disposable adhesive mastoid electrodes, diameter 24 mm, 50 pcs, for use with g.SAHARAclipREF and with g.SAHARAclipGND, no gel
1032	disposable Ag/AgCl electrodes	35 mm, for EMG, ECG; 50 pieces; pre-gelled
1043	double-sided adhesive washers	500 pieces; for 20 mm g.LADYbird electrodes
1042	double-sided adhesive washers	500 pieces; for 14 mm reusable EOG Ag/AgCl electrodes





Sensors

CONTINUOUS NON-INVASIVE BLOOD PRESSURE MONITORING

g.CNAP is a world-leading system for non-invasive blood pressure recording and can be used as a stand-alone system as well. The analog output signal (continuous BP in mmHg) can be recorded together with other parameters and biosignals with g.tec systems.



Product no.	Product name
2044a	g.CNAPsensor
Description	
continuous non-invasive arterial pressure monitor, with finger cuffs and upper arm cuff for calibration, graphic and numeric display; mains (110 – 230 V, 50/60 Hz) and battery powered, analog interface box (1x9V battery supplied), 1 mV=1 mmHg, output cable with touchproof connectors (2045) included	

SNORING SENSOR

Piezo-electric snoring sensor for sleep research. Picks up tracheal sounds. To be placed on the neck of the patient.



Product no.	Product name	Description
2001	g.SNORINGsensor	piezo sensor; is intended to detect tracheal sounds; output of 1 to 5 mV; no power supply needed; 5 - 70 Hz, incl. jumper cable, output: 1.5 mm touch proof connectors

TEMPERATURE SENSOR

20° C - 45° C, for skin temperature, accuracy: 0.2° C
The sensor is already calibrated and provides an output voltage of 0 ... 200 mV



Product no.	Product name	Description
2037	g.TEMPsensor	sensor for changes in skin temperature (20 – 45 °C, accuracy 0.2 °C), 9V battery supplied, output 0 - 200 mV; DC - 1 Hz, output cable with touchproof connectors (2045) included



RESPIRATION AIRFLOW SENSOR



This thermistor sensor is placed in front of nose and mouth and measures temperature changes in inhaled and exhaled air. The resulting respiration signal is very robust against movement artifacts.

Product no.	Product name
2043	g.FLOWsensor
Description	
thermistor flow sensor (nose and mouth), battery life time min. 1 year, output: 1.5 mm touch proof connectors ± 1 mV: DC - 20 Hz, incl. jumper cable	

RESPIRATION EFFORT SENSOR



Piezo-electric crystal sensor in a robust belt system. Can be used to record chest and abdominal respiration waveforms independently. Our respiration sensors connect directly to amplifier inputs.

Product no.	Product name	Description
2002	g.RESPsensor	piezoelectric respiration sensor; measures respiration efforts; output of +/- 1mV; no power supply needed; 0.01 - 60 Hz, incl. jumper cable, output: 1.5 mm touch proof connectors

OXYGEN SATURATION



Two light sources with different wavelengths are used to measure the saturation of oxygen in the blood (SpO₂). The sensor can be placed on the index finger. A calibrated output signal is provided.

Product no.	Product name	Description
2041	g.SpO2sensor	oxygen saturation, finger sensor; output ± 250 mV; DC - 1 Hz, 2xAAA battery supplied, output cable with touchproof connectors (2046) included



PULSE

Compact and light-weighted plethysmographic pulse sensor. Earlobe or finger transducers available. Provides a clear analog pulse wave signal (e.g. to be recorded together with ECG)



Product no.	Product name	Description
2005	g.PULSEsensor	photoelectric pulse sensor for pulsatile blood flow recording, peripheral circulation studies; monitors changes in reflected light from fingers; output: 1.5 mm touch proof connectors, +/- 1 mV; 0.01 - 60Hz; with velcro strap

GALVANIC SKIN RESPONSE

Also called EDA (electro-dermal activity) or skin conductance. Two small electrodes are used, preferably on the fingers without any gel. The isolated circuit guarantees no interference with other electrodes on the body. Individual baseline adjustment.



Product no.	Product name	Description
2035	g.GSRsensor	galvanic skin response sensor with finger electrodes; 9V battery supplied; only connect to medical safe data acquisition system with $\pm 250\text{mV}$; 0(DC) - 20 Hz, output cable with touchproof connectors (2045) included

ACCELERATION

3-axes, +/- 3 g acceleration sensor. Can be applied on the subject's body or directly in a simulator, vehicle or airplane to monitor g-forces, acceleration and vibration



Product no.	Product name	Description
2039	g.Gsensor	range: $\pm 3\text{g}$; 3-axis-acceleration/vibration-sensor; with $\pm 250\text{ mV}$ output, 9V battery supplied, output: 1.5 mm touch proof connectors

LIMB MOVEMENTS

This piezo-electric sensor is placed on the ankle to detect movements of the feet during sleep. For investigation of restless leg syndrome (RLS) and periodic limb movements (PLM).



Product no.	Product name	Description
2040	g.LIMBsensor	piezo limb movement sensor, detects sudden movements during sleep, output max. $\pm 50\text{ mV}$, no power supply needed, incl. jumper cable, output: 1.5 mm touch proof connectors



 Lectures and Books

Lectures

g.tec introduces lectures for biosignal recording and analysis. The lectures are divided into a manual which contains the theoretical background, hands-on examples and several tasks to solve. The second part is a manual which contains only the solutions for the tasks.

The lectures allow researchers to get a quick start in the specific field and to perform already state of the art experiments after just a few hours. The lectures are also perfectly suited for teaching because of the separation of tasks and solution manuals.

LECTURE 1: THE ELECTROENCEPHALOGRAM

The Electroencephalogram (EEG) is a tutorial which introduces the reader into EEG recordings and analysis methods. The reader will learn how to assemble electrodes correctly, how to setup the recording equipment appropriately and how to make high-quality EEG recordings. Furthermore several EEG experiments have to be performed which give already a deep insight into state-of-the-art EEG analysis topics.

Objectives	
<ul style="list-style-type: none"> ◆ Learn to assemble electrodes according to the 10-20 system ◆ Learn to assemble electrodes with EEG caps and screwable electrodes ◆ Test the impedance of the EEG electrodes ◆ Learn how to connect the electrodes to the amplifier to make monopolar and bipolar recordings ◆ Learn how to test the recording setup ◆ Learn to recognize alpha and beta rhythms ◆ Learn to recognize artifacts in the EEG recording ◆ Learn to eliminate artifacts from the EEG recording ◆ Investigate the alpha block during a mental task ◆ Investigate hemispheric differences during language and spatial processing ◆ Learn how hyperventilation affects the EEG ◆ Learn the EEG differences of introverts and extraverts 	<p>Average time to perform the lecture: 450 min</p> <p>Pages of lecture: 47</p> <p>Pages of solutions for lecture: 24</p>

LECTURE 2: THE BRAIN-COMPUTER INTERFACE

The Brain-Computer Interface (BCI) is a tutorial which introduces the reader into BCI experiments and analysis methods. The reader will learn how to analyze BCI data in off-line and on-line mode and to set up real-time Simulink models for BCI experiments. Experiments will be introduced which can be used to acquire EEG data for training the computer on subject specific patterns and also for real-time feedback in order to control a cursor on the screen. Several examples of parameter extraction algorithms like bandpower, Hjorth and adaptive autoregressive models (AAR) will be explained. Classification algorithms like linear discriminant analysis (LDA) and neural networks (NN) are also subject of the lecture. The reader has to perform several tasks which give a deep insight into state-of-the-art BCI processing steps.

Objectives	
<ul style="list-style-type: none"> ◆ Learn pre-processing steps for BCI data analysis ◆ Calculate the power spectrum and event-related desynchronization of EEG data ◆ Extract features of the different EEG channels ◆ Train different classifiers to discriminate the features ◆ Compare feature extraction and classification algorithms ◆ Contact BCI experiments without feedback to get data for pattern recognition ◆ Perform real-time BCI experiments with cursor feedback ◆ Learn to write processing batches for fast off-line analysis ◆ Extract reactive frequency components out of the EEG data ◆ Modify real-time analysis models for optimal performance ◆ Train yourself to reach a high BCI classification accuracy 	<p>Average time to perform the lecture: 465 min</p> <p>Pages of lecture: 89</p> <p>Pages of solutions for lecture: 28</p>



LECTURE 3: THE ELECTROCARDIOGRAM

The ECG lecture is intended to give a practical entry to state-of-the-art ECG processing. In the course of 6 lessons, the reader is confronted with common tasks of modern ECG analysis and it is shown how to practically solve the problems. Each lesson starts with a theoretical part to provide enough knowledge to solve the tasks.

Objectives

- ◆ Measure Einthoven-, Goldberger- and Wilson-derivations
- ◆ Perform 12 lead derivations
- ◆ Learn to identify and avoid artifacts in the ECG signals
- ◆ Calculate single beat intervals and amplitudes
- ◆ Perform automatic QRS complex detection
- ◆ Program an off-line and on-line QRS complex detector
- ◆ Analyze tilt table experiments
- ◆ Detect arrhythmias and abnormalities

Average time to perform the lecture: 700 - 760 min

Pages of lecture: 58

Pages of solutions for lecture: 71

LECTURE 4: EVOKED POTENTIALS

The Lecture Evoked Potentials explains the recording and analysis of auditory steady-state responses (ASSRs), the auditory P300 response and brainstem auditory evoked potentials (BAEP). Each of these methods is important in clinical Electroencephalography. The auditory P300 response furthermore can be used as interaction method within a Brain Computer Interface (BCI).

Objectives

- ◆ Configure the auditory stimulator correctly for EPs
- ◆ Record and analyze P300 responses
- ◆ Record and analyze ASSRs
- ◆ Record and analyze BAEPs
- ◆ Perform step-by-step the off-line analysis
- ◆ Run analysis batches to evaluate the captured EPs

Average time to perform the lecture: 330 min

Pages of lecture: 65

Pages of solutions for lecture: 24

LECTURES

Product no.	Product name	Description
4050	Lecture 1: EEG	EEG teaching lecture
4051	Lecture 2: BCI	BCI teaching lecture
4052	Lecture 3: ECG	ECG teaching lecture
4053	Lecture 4: Evoked Potentials	Evoked Potentials teaching lecture

Books

Some books with g.tec contributions



**ELECTROENCEPHALOGRAPHY:
Basic Principles, Clinical Applications, and Related Fields**

Edited by: Ernst Niedermeyer, Fernando Lopes da Silva

ISBN: 978-0-7817-5126-1

Publisher: Lippincott Raven

Publication Date: 5. Edition, November 22, 2004

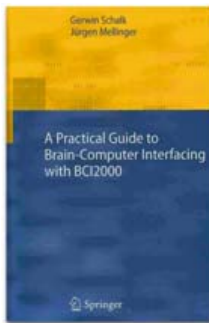

**A Practical Guide to
Brain-Computer Interfacing with BCI2000**

Edited by: Gerwin Schalk, Jürgen Mellinger

ISBN: 978-1-84996-091-5

Publisher: Springer

Publication Date: 1. Edition, April 15, 2010

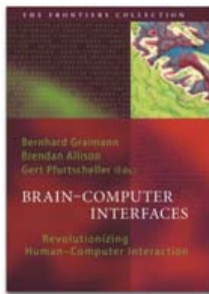

**BRAIN-COMPUTER INTERFACES:
Revolutionizing Human-Computer Interaction**

The Frontiers Collection

Edited by: Bernhard Graimann, Brendan Allison, Gert Pfurtscheller

ISBN: 978-3-642-02090-2

Publisher: Springer

Publication Date: 1. Edition, July 01, 2010

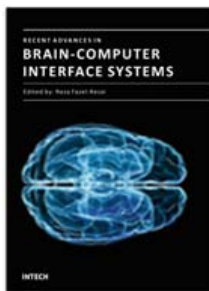

**RECENT ADVANCES IN
BRAIN-COMPUTER INTERFACE SYSTEMS**

Edited by: Reza Fazel

ISBN: 978-953-307-175-6

Publisher: InTech

Publication Date: February, 2011



Springer Handbook of Medical Technology

Edited by: Rüdiger Krampe, Klaus-Peter Hoffmann, Robert Steven Pozos

ISBN: 978-3-540-74657-7

Publisher: Springer

Publication Date: 1. Edition, September 18, 2011

Customer Training

CUSTOMER-TRAINING IN G.TEC OFFICE

g.tec's research systems are powerful tools and open a wide range of possible applications. For our customers, we can provide personal training at g.tec's facilities here in Austria. Get a general introduction to your systems, see some basic experiments and application examples or discuss special hardware- and software solutions with our developers, programmers and application engineers. The training is most effective if you come with your own g.tec system to guarantee that all the settings are performed correctly on your system.

Both branches (Graz and Schiedlberg) offer space for groups of up to 6 members of your team for the training.

Just contact us about a schedule for your training. We can also help you to organize your travel and accommodation.

Hope to see you in Austria!

TRAINING AT YOUR INSTITUTION

If multiple lab members are interested in operating g.tec systems, it is more effective to send a g.tec team member directly to your institution to train the whole group.

Just contact us to schedule a training event suitable for your team.

WORKSHOPS AT YOUR INSTITUTION

If your lab plans to organize a workshop or satellite event at your institution, we will be happy to send a researcher who can talk about brain-computer interfaces, spike recordings, real-time physiology analysis, Virtual Reality systems, and related topics. Typically such workshops last for about 2 hours up to 2 days.

TRAINING TOPICS

Course 1: Off-line biosignal analysis (EEG, ECG, GSR, respiration) with g.BSanalyze - 1/2 day course

Course 2: Measuring biosignal data (EEG, ECG, GSR, respiration, EMG, EOG, ECoG, pulse, SpO2, etc.) with g.USBamp/g.MOBllab+ - 1/2 day course

Course 3: Running BCI (P300, motor imagery, SSVEP) experiments in real-time - 1 day course

Course 4: Measuring EPs (BAEP, ASSR, P300, N200,...) - 1/2 course

Course 5: Extending the biosignal analysis with custom software modules under MATLAB/Simulink - 1/2 day course

Course 6: Acquiring and analyzing spikes - 1/2 day course

Course 7: Run Virtual Reality and physiology experiments successfully - 1/2 day course

WORKSHOP TOPICS

Workshop 1: Brain-computer interface - 1/2-1 day workshop

Workshop 2: Spike and ECoG recordings - 1/2 day workshop

g.tec medical engineering GmbH

Sierningstrasse 14
4521 Schiedlberg
Austria

phone +43 7251 22240-0
fax +43 7251 22240-39
email office@gtec.at

authorized distributor: